

INTELLIGENT
PANEL
METERS

Series

FEMIA ELECTRÓNICA

Intelligent Panel Meters



TAS-P
TAS-T
TAS-R

Process
Temperatures
Resistances &
Potentiometers

USER'S MANUAL

INDEX

1.- Connections	3
2.- Programming Menu	3
3.- Configuration	
3.1.- Input Signal	4
3.2.- Direct Access	
3.2.1- Decimal Point Position	4
3.2.2- Adjusting the «Low Indication» Value	4
3.2.3- Adjusting the «High Indication» Value	4
3.2.4- Alarm Setpoints	4
3.2.5- Correcting the «Low Input Signal»	4
3.2.6- Correcting the «High Input Signal»	4
4.- Advanced Configuration	
4.1.- Process Signals	
4.2.- Manual adjustment	5
4.3.- «Low Signal» correction type	5
4.4.- Temperature Signals	5
4.5.- Advanced Temperature	5
4.6.- Dealing with Errors	5
4.7.- Alarm Configuration	6
4.8.- Advanced visualization	6
4.9.- Blocking the keypad	6
4.10.-Resetting the instrument. Default values	6
4.11.-Messages and errors	7
5.-Configuring via PC	7
6.-Technical Specifications	8
7.-Options	9
7.1- Options EXP, AL2 and AL4	9
7.2- Option TSAT (Analogue output)	10
7.3-Option R48M (Modbus output)	12
7.3.1-Modbus Structure	13
7.4-Option TEK (Peak,Valley,Hold,Tare.Reset)	14
7.-Certification CE / Warranty	15
8.- Installation Precautions	15

READ.ME FIRST

* When the instrument is powered, a message displays the configured signal (see section 2 or section 4)

* If while in operation, the instrument shows a message on display see section 4.11 «Messages and Errors»

* The frontal keypad of the instrument has two functions, «numerical» and «direct access» function :

Key AL -	Access to the alarm setpoint
Key HI -	High display value (High)
Key LO -	Low display value (Low)
Key ADJ -	Field correction
Key DP -	Decimal Point position
PROG -	introduce programming codes (4 digit codes, see section 4)

* MESSAGE «TIME».- The current programming procedure has been stopped because there has been no interaction from the user for the last 5 seconds

* SIGNAL RANGES.- To work with a signal range which is not directly shown in this manual, select the closest upper range and change the calibration parameters with code [14 11].

* Example .- to configure a 0/5 Vdc signal from a 0/10 BAR transducer :

- 1.- select the 0/10 Vdc range
- 2.- enter code [14 11]
- 3.- edit 0 Vdc = 0 and 5 Vdc =10,000

* If afterwards the value of 10.000 needs to be changed, it can be directly accessed and changed with key «HI».

1.- CONNECTIONS

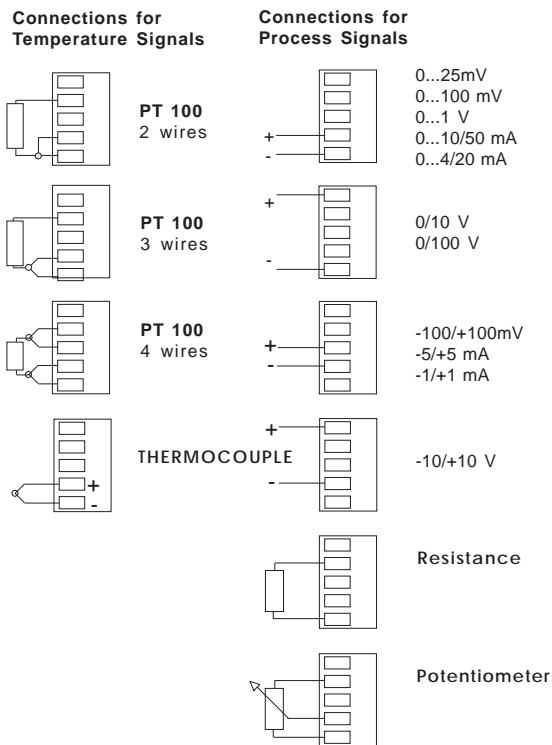
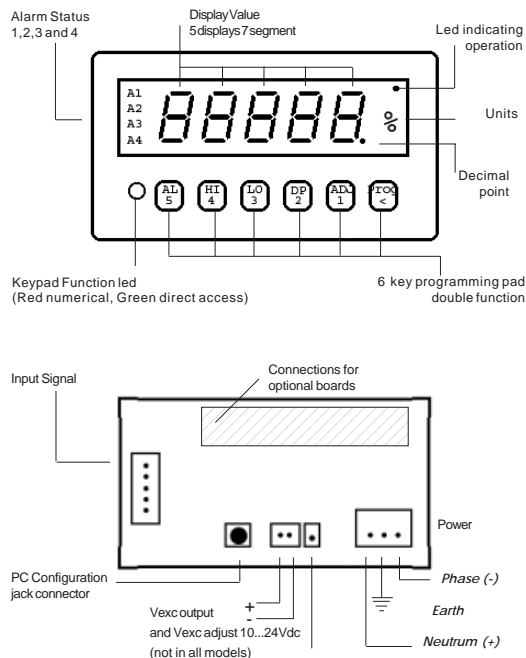

2.- PROGRAMMING MENU

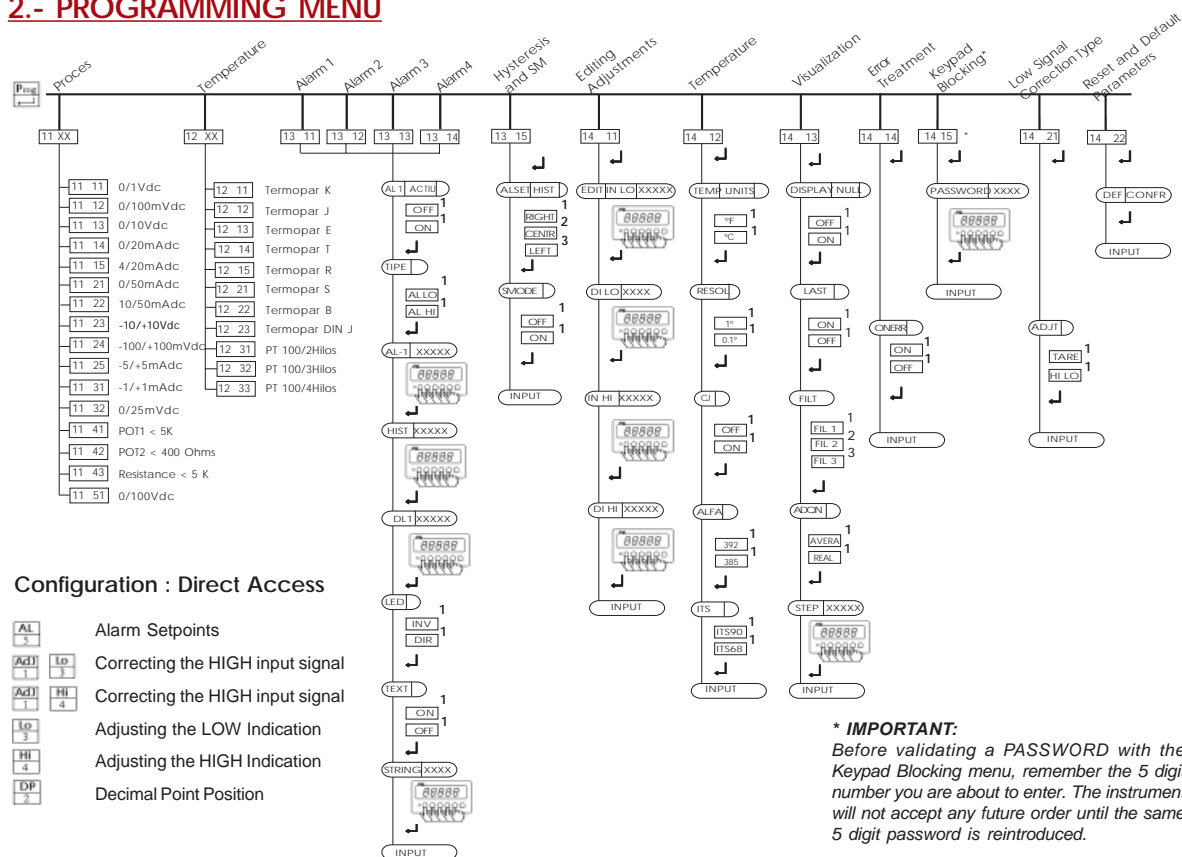

3- CONFIGURATION

Section 3.1 shows how to enter a code to select a defined input signal range. Codes are indicated in section 2. Examples in section 3.2 show how to use Direct Access buttons on frontal keypad in order to configure a input of 4/20 mA with an indication of 0.0 / 250.0 using the field correction signal function «ADJ HI» and «ADJ LO».

It is also possible to directly configure the relation input signal Vs reading using the configuration code [14 11]. The following example is for a process instrument. Temperature instruments do not allow to modify the display, because the indication is direct from the temperature probe signal.

3.1- INPUT SIGNAL

The TAS units have several built-in predefined input signal ranges, selectable with the help of codes (4 digit codes). On page 4 there is a list of all accessible ranges and the codes associated.

3.2- DIRECT ACCESS

The frontal keypad has several direct access buttons for a quick configuration of the instrument :

- Pad 1 (ADJ) - Correct the LOW or HIGH input levels
- Pad 2 (DP) - Decimal Point Position
- Pad 3 (LO) - Set for the LOW indication level
- Pad 4 (HI) - Set for the HIGH indication level
- Pad 5 (AL) - Alarms Setpoint

3.2.1- DECIMAL POINT POSITION

Activate the Decimal Point at position XXX.XX

- 1- Press **DP**
 - 2- message «DP» during 1 second
Press 2 to fix decimal point position **3**
(To fix at other positions, press 1,2,3,4 or 5)
 - 3- Validate changes pressing **↵**
- message «INPUT» shows the configuration has been accepted

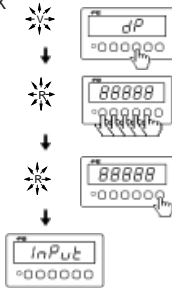

3.2.2- ADJUSTING THE LOW INDICATION VALUE

For the low input level (4 mA) we want to configure a low indication of 000.00

- 1- Press **Lo**
 - 2- Current value for the low indication is displayed. Modify it by pressing on **1,2,3,4,5** until we see 00000
 - 3- Validate the changes pressing **↵**
- message «INPUT» shows the configuration has been accepted

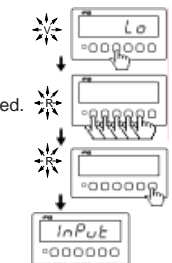

3.2.3- ADJUSTING THE HIGH INDICATION VALUE

For the high input level (20 mA) we want to configure a high indication of 100.00

- 1- Press **Hi**
 - 2- Current value for the high indication is displayed. Modify it by pressing on **1,2,3,4,5** until we see 10000
 - 3- Validate the changes pressing **↵**
- message «INPUT» shows the configuration has been accepted

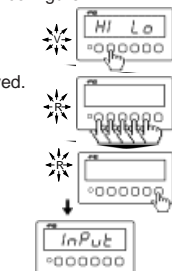

CONFIGURING A 4/20mA INPUT SIGNAL RANGE (Code 11 15 ; as shown on table on section 2)

- 1- Press message «Prog» during 1 second blank screen **Prog**
- 2- Input the code **11 15**
- 3- Validate the code pressing **↵**
- 4- Message showing the selected range «4 20» during 1 second

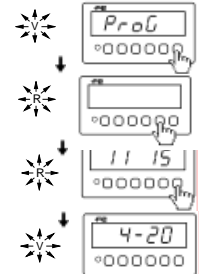

3.2.4- ALARM SETPOINTS

Fix the setpoint for Alarm1 at 10500

- 1- Press **AL**
 - 2- Enter the number of the alarm we want to modify **1**
 - 3- Current value for Alarm1 setpoint is displayed. Modify it by pressing on **1,2,3,4,5** until we see 10500
 - 4- Validate the changes pressing **↵**
- message «INPUT» shows the configuration has been accepted

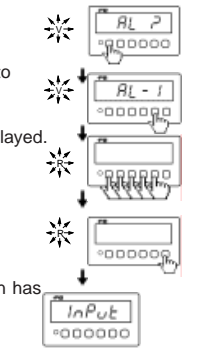

3.2.5- CORRECTING THE LOW INPUT SIGNAL (OFFSET)

Allows offset correction, by linking the current input signal on terminals to the Low Indication Value memorized.

- 1- Generate the low input level signal
- 2- Press Adjust **Adj**
The instrument asks «Hi» or «Lo» ?
- 3- Press **Lo**
- 4- Message «Cr Lo» shows the unit has corrected the low level value, linking the current input signal value to the low indication value memorized (LO keypad)

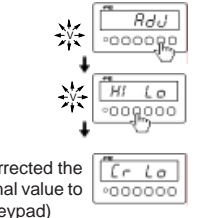

3.2.6- CORRECTING THE HIGH INPUT SIGNAL

Allows to link a current signal at the input terminals to the High Indication Value memorized on the HI keypad.

- 1- Generate the high input level signal
- 2- Press Adjust **Adj**
The instrument asks «Hi» or «Lo» ?
- 3- Press **Hi**
- 4- Message «Cr Hi» shows the unit has corrected the high level value, linking the current input signal to the high indication value memorized (HI keypad)

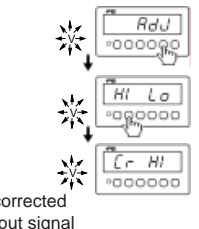

4-ADVANCED CONFIGURATION

4.1- PROCESS SIGNALS

Codes : 11 XX

Input	Code	Message
0/1V	11 11	1U
0/100mV	11 12	100nU
0/10V	11 13	10U
0/20mA	11 14	0-20
4/20mA	11 15	4-20
0/50mA	11 21	0-50
10/50mA	11 22	10-50
-10/10V	11 23	b 10U b 100n
-100/100mV	11 24	b 5nA
-5/5mA	11 25	b 1nA
-1/1mA	11 31	25nU
0-25mV	11 32	P0t1
potentiometer<5K	11 41	P0t2
potentiometer<400	11 42	rES
resistance <5K	11 43	100U

4.4- TEMPERATURE SIGNALS

Codes : 12 XX

Input	Code	Message
Thermocouple K	12 11	tEr t
Thermocouple J	12 12	tEr u
Thermocouple E	12 13	tEr E
Thermocouple T	12 14	tEr t
Thermocouple R	12 15	tEr r
Thermocouple S	12 21	tEr S
Thermocouple B	12 22	tEr b
Thermocouple DIN J	12 23	tE d u
PT-100 (RTD) 2 wire technic	12 31	Pt 2
PT-100 (RTD) 3 wire technic	12 32	Pt 3
PT-100 (RTD) 4 wire technic	12 33	Pt 4

4.2- MANUAL ADJUSTMENT

Code : 14 11 Function : Edt

Parameters	Values	Function
In Lo	number	Input Low - Low Input Signal
d1 Lo	number	Display Low - Indication for Low Signal
In Hi	number	Input High - High Input signal
d1 Hi	number	Display High- Indication for High Signal

Code 14 11 can be used both to modify adjustments and to visualize current values.

4.5- ADVANCED TEMPERATURE

Code : 14 12 Función : tEnP

Parameters	Values	Function
UNITs	°C °F	Centigrade Degrees Fahrenheit Degrees
RESOL	1 0.1	1 degree resolution 0.1 degree resolution
CJ	On OFF	Thermocouple Cold Junction Compensation
ALFA	385 392	Standard for PT-100 (RTD) 385 - DIN Standard 392 - ANSI Standard
ITS	ITS68 ITS90	Calibration Standard ITS 68 ITS 90.

4.3- LOW SIGNAL CORRECTION TYPE*

Code : 14 21 Function : Adj

Parameters	Values	Function
Adj	tArE	TARE function. Adjusts the low level moving the high level the same quantity.
	HI Lo	Adjusts low and high level independently, when using ADJ Direct Access keypad.

* Selects the type of action to perform when selecting the ADJ Direct Access key.

4.6- DEALING WITH ERRORS

Code : 14 14 Function : onErr

Parameters	Values	Function
onErr	on	Activates all alarms in case of error state *
	OFF	Deactivates all alarms in case of error state*

* More information on «what is an error», on section 4.7 «Messages»

4.7-ALARM CONFIGURATION

Alarm Number	CODE	Menu
Alarm 1	13 11	Alarm Parameters
Alarm 2	13 12	Alarm Parameters
Alarm 3	13 13	Alarm Parameters
Alarm 4	13 14	Alarm Parameters
General	13 15	Hysteresis and SM

Menu : Alarm Parameters

Parameters	Values	Description
AL1	ON OFF	Alarm1 working Alarm1 not working
AL1PE	AL HI AL LO	Alarm1 working as «maximum» Alarm1 working as «minimum»
AL-1	88888	Setpoint for Alarm1 (expressed in display points)
H1St	88888	Hysteresis value (max. 255) (expressed in display points)
dL1	88888	Delay on relay activation (expressed in seconds)
LED	dir InU	Led is active when alarm is active Led is active when alarm is inactive
ALt	ON OFF	Alarm text active Alarm text inactive
Strng	88888	Text associated with alarm led

The alarm configuration menu list several parameters to which we must assign a value.

Numerical values are assigned with the number pads. Predefined values (such as ON/OFF) are selected by selecting available options with keys '1', '2' or '3'.

Validate with key 'J' in order to access next parameter.

Menu : Hysteres and SM

Parameters	Values	Function
H1St	LEFT	Hysteresis is applied to the process of alarm deactivation*
	CENTER	Band alarm. Hysteresis is applied to the process of alarm activation and deactivation*
	RIGHT	Hysteresis is applied to the process of alarm activation.* <small>*The hysteresis points are defined on parameter HYST for each alarm.</small>
SMODE	ON OFF	Security Mode activated on alarms acting as «minimum»** Security Mode deactivated <small>**Output relay are inactive until the set point is reached for the first time.</small>

4.8-ADVANCED VISUALIZATION

Code : 14 13 Function : *DISPL*

Parameters	Values	Function
NULL	ON OFF	No zeros active to the left Zeros active to the left
LAST	ON OFF	Fixes the least significant digit to zero Frees the least significant digit
FLt	FL1 FL2 FL3	Fast filter on the input signal : 0.25 Seg 98% Medium filter on the input signal : 0.5 Seg 98% Slow filter on the input signal: 1 Seg. 98%
Ad3n	REAL AVERA	Real time indication Indication of mean values
StEP	88888	Time (between 1 and 255 seconds) to calculate mean values for mean indication

4.9- BLOCKING THE KEYPAD

Code : 14 15 Function : *PASSWord*

Parameters	Values	Function
'PASSWord	00000	Blocks the frontal keypad Password is made of a numerical value of 5 digits

4.10-RESETTING THE INSTRUMENT

Code : 14 22 Function : *DEFConf*

Resets the unit to the default manufacturing values. It is needed to reconfirm the action by pressing INTRO after the message *DEFConf*

Parameters	Default Values
Input Signal	4-20mA
Lo - Low Level Indication	0
HI - High Level Indication	10000
Decimal Point	0 0 0 0 0.
Acquisition Mode	Real
STEP	10
Zero Blanking	ON
Last digit to zero	OFF
Display Filter	Filter 2 (0.5 seg.)
Temperature Units	°C
Temperature Resolution	0.1°
Temperature : ALFA Parameter	ALFA 385
Temperature: Measuring Standard	ITS 68
Password	deactivated

	Setpoint	Hyst	Delay	Type	Led	Text	String
Alarm 1	ON	1000	1	0	H	DIR	OFF AL-1
Alarm 2	ON	1000	1	0	H	DIR	OFF AL-2
Alarm 3	ON	1000	1	0	H	DIR	OFF AL-3
Alarm 4	ON	1000	1	0	H	DIR	OFF AL-4

Hysteresis	CENTER
Security Mode	ON
On Error	OFF

4.11-MESSAGES AND ERRORS

Messages and errors are active when the instrument senses a «not normal» situation . The instrument identifies the type of «anormality» and informs with an error or with a message.

Messages

«Messages» are associated with non-critical situations, those which only affect the measure temporary. The «message» remains active on display until the situation clears. The instrument recovers the normal working state when situation clears..

L o U Current on the loop is lower than the minimum.*
*On a 4/20mA loop, current is below 4 mA

- o U r The input signal is lower than selected range

o U r The input signal is higher than selected range

t i m E Security waiting time exceeded while in configuration mode. The instrument rolls-back to the previous configuration

E r r o r Error when entering a data. Value not accepted. Reintroduce the value. (Typical case : The value assigned to hysteresis is higher than 255)

d E r r o Error on Display Indication
Trying to display a value higher than 32000 or lower than -19999. Reduce HI and LO levels dividing by 10.

Errors

«Errors» are associated with critical situations which disable the ability to measure the signal.

The «error» remains active on display until the situation disappears. At this time, the instrument recovers normal functionality.

«Errors» execute actions on alarms, activating or deactivating them depending on the status of variable OnErr (see page.11). Alarms recover their normal behaviour when the the error state clears.

b r t Sensor not connected or open connection
(example : PT100 probe broken)

[o n Connctions not correct
(example : cables incorrectly connected on the input terminals)

o P E n The current loop is open or current in the loop is zero
(example : 4/20mA loop is open)

E r r O Internal Error. Restart the instrument.
** It is possible that no action is performed on alarms if this error is affecting the internal EPROM

n E r r O Mathematical Error 0
Parameters introduced for the input signal are not coherent. (Typical case : the high level value is similar or very close to low level value, on input signal range or indication)

n E r r 1 Mathematical Error 1: mathematical overflow.
The unit is trying to process values higher than 32000 or lower than -32000.

5-CONFIGURING VIA PC

To configure TAS unit from software you need the configuration software (available on www.fema.es) and the PCConnector cable (Optional, check with your distributor). The PCConnector is connected to the SUB-D 9 pins serial port of the computer and the communications jack to the TAS instrument. When executing the software:

- 1.- Select the COM port
- 2.- Press «START COMM»
- 2.- The configuration windows open

The configuration of the instrument and the alarms is done from the main display window. Options are configured from an indepent window which opens to the right. Changes in the configuration are automatically downloaded, or can be forced to download by pressing «WRITE_D» button.

Configuration caba saved to a file with the «SAVE_F» button. Configurations for the instrument and alarms and configuration for the option boards are sabled in independent files.

Selet COM
press «START COM»

Press «WRITE_D»
to force download
configuration to the
instrument



Window to configure the
options

Process
Adjust

Input signal
ranges

6- TECHNICAL SPECIFICATIONS

VOLTAGE SIGNALS

Ranges	0...25mV, 100mV, 1V, 10V, 100V, ± 100 mV, ± 10 V
Accuracy	0,05% of reading ± 1 point
Thermal Drift	± 100 ppm/ $^{\circ}$ C
Input Impedance	10 MOhm for $V_{in} < 1$ V 500KOhm for $V_{in} > 1$ V
Effective Resolution	32.000 points

CURRENT SIGNALS

Ranges	0/4...20mA, 0/10...50mA, ± 1 mA, ± 5 mA
Accuracy	0,05% of reading ± 1 point (plus 0.02% F.S. for 4...20mA and 10...50mA)
Thermal Drift	± 100 ppm/ $^{\circ}$ C
Input Impedance	3V drop, 10 Ohms (equivalent to 160 Ohm at 20mA)
Effective Resolution	> 32.000 points

PT100 (RTD) SIGNALS

Configuration	2, 3 and 4 wire configurable
Excitation current	250 μ A
Range	-200 to $+850^{\circ}$ C (4-400 Ohm)
Accuracy	$\pm 0,3^{\circ}$ C Typical ($\pm 0,5^{\circ}$ F)
Cable Compensation	10 Ohm
Thermal drift	0,1 $^{\circ}$ C / $^{\circ}$ C
Units	$^{\circ}$ C / $^{\circ}$ F
Resolution	1 $^{\circ}$ / 0,1 $^{\circ}$

Programmable response to sensor break

THERMOCOUPLE SIGNALS

Type	Range	Accuracy
J	-210 $^{\circ}$ C ... $+750^{\circ}$ C	0,5 $^{\circ}$ C
K	-270 $^{\circ}$ C ... $+1370^{\circ}$ C	0,5 $^{\circ}$ C
T	-270 $^{\circ}$ C ... $+400^{\circ}$ C	0,5 $^{\circ}$ C
B	0 $^{\circ}$ C ... $+1800^{\circ}$ C	1,0 $^{\circ}$ C
E	-270 $^{\circ}$ C ... $+1000^{\circ}$ C	0,5 $^{\circ}$ C
R	-50 $^{\circ}$ C ... $+1770^{\circ}$ C	0,7 $^{\circ}$ C
S	-50 $^{\circ}$ C ... $+1770^{\circ}$ C	0,7 $^{\circ}$ C
DIN «J»	-210 $^{\circ}$ C ... $+750^{\circ}$ C	0,5 $^{\circ}$ C

Units	$^{\circ}$ C / $^{\circ}$ F
Resolution	1 $^{\circ}$ / 0,1 $^{\circ}$
Cold Junction Compensation	Internal / External
Accuracy for the «CJC»	0,5 $^{\circ}$ C a 25 $^{\circ}$ C
Thermal drift included compensation	0,15 $^{\circ}$ C/ $^{\circ}$ C Típica

Programmable response to sensor break

POTENTIOMETER SIGNALS

Range	100 to 400 Ohms 400 to 5 KOhms Expansible with external resistance
Excitation current	250 μ A
Accuracy	0,05% F.S.
Resolution	>10.000 Puntos
Thermal drift	± 100 ppm/ $^{\circ}$ C

Programmable response to sensor break

RESISTANCE SIGNALS

Range	0...5 KOhm
Excitation current	250 μ A
Accuracy	1 Ohm ± 1 point
Resolution	0,2 Ohm
Thermal drift	± 100 ppm/ $^{\circ}$ C

Programmable response to sensor break

OPTIONS

Option EXP, AL2 and AL4
Option TSAT
Option R485M
Option TEK

INDICATION

Display	5 Digits, 7 Segments, Red Led High Brightness
Digit Height	14,2 mm. / 0,56"
Filter	Anti-reflexive.
Indication	From - 19999 to 32000
Refresh	5 /seg. (Filter selectable)

A/D CONVERTER

Speed	14 Readings / Second
Accuracy	16 BIT + sign (± 65.000 points)
CMRR	> 130 dB

EXCITACIÓN VOLTAGE FOR TRANSDUCERS

Voltage	10 to 24 Vdc. regulated (adjustable)
Isolation	500 Vdc
Current	50 mA. Maximum

Note .- Excitation Voltage not included in all models

POWER

Standard	230 Vac 50/60 Hz. Consumption 3,5W Max
Optional	115 Vac 50/60Hz. Consumption 3.8W Max
Optional	24 Vdc ($\pm 10\%$) isolated. Consumption 4W Max Isolation 1000 Vdc (Primary - Secondary) Maximum consumption at 24 Vdc .- 265 mA Peak current at start-up <600mA

ENVIRONMENTAL DATA

Working Temperature	0 ... $+50^{\circ}$ C
Storage Temperature	-20 ... $+85^{\circ}$ C
Humidity	0 ... 85%, non condensaded

MECHANICAL DATA

Dimensions	Standard 1/8 DIN 96 x 48 x 124 mm. (3,78" x 1,89" x 4,88") Protection IP65 (NEMA 4)
Front	
Weight	0,5 Kgs

SIZES AND PANEL CUT-OUT

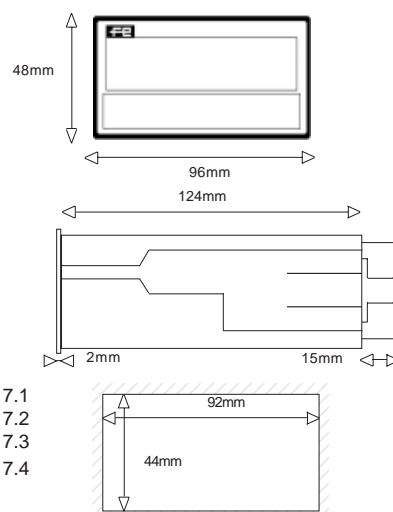

7- AVAILABLE OPTIONS - INSTALLING AND CONFIGURING

The TAS instruments allow several different options to be added to the standard unit. Several requirements between options are needed in order to add an option to a standard TAS unit. Not all options can be added to the same instrument at the same time.

- EXP** Expansion Bus
- AL2** 2 Relay Outputs and Expansion Bus
- AL4** 4 Relay Output (without Expansion Bus)

Note .- Only 1 of these options can be added to the instrument

TSAT Analogue output. Requires Expansion Bus option. Not compatible with R485M option

R485M Modbus Output. Requires Expansion Bus option. Not compatible with TSAT option

Note .- Only 1 of TSAT or R485M can be added to a TAS instrument, the unit must have also the Expansion Bus

TEK Remote Contacts. Requires Expansion Bus option.

Note .- Can only be added if the TAS instrument has the Expansion bus option. The TEK option can share the bus with 1 TSAT or with 1x R485M or can be installed alone.

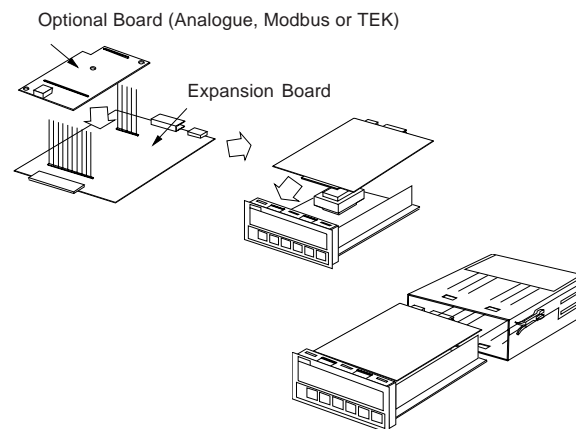

7.1- OPTIONS EXP, AL2 AND AL4

Option EXP The EXP allows other options (TSAT, R485M and TEK) to be added to a TAS instrument, without adding relays.

Option AL2 Option board with 2 Relay output contacts. Relays are controlled by alarms 1 and 2. Includes «Expansion Bus» which allows more options to be installed (TSAT, R485M, TEK)

Option AL4.- Option board with 4 Relay output contacts. Relays are controlled by alarms AL1, AL2, AL3 and AL4. No additional options can be added

Technical data on relays

Type ON/OFF	2 A. (non inductive)
Maximum Current	250 Vac
Maximum Voltage	isolated between each other
Terminals isolated	isolated from power supply
	isolated from signal

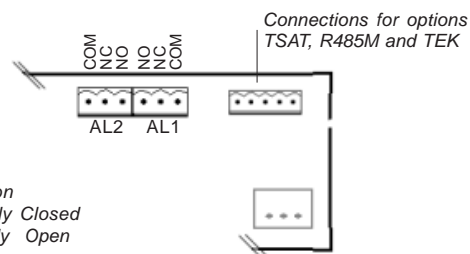
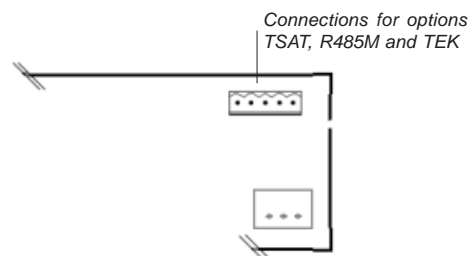

COM Common
NC Normally Closed
NO Normally Open

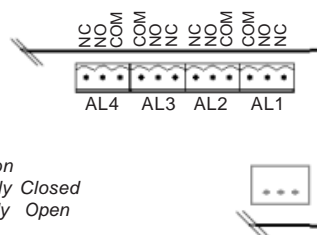

COM Common
NC Normally Closed
NO Normally Open

7.2 - ANALOG OUTPUT - TSAT OPTION BOARD

The TSAT board adds analog output capabilities to the TAS-1 instruments. Jumper selectable for voltage (0/10 Vdc) and for current (4/20mA and 0/20mA in modes SINK and SOURCE) adds a galvanic isolation of 2KVe_{ff}.

readjustment of the TAS-1 series, meaning that when readjusting the input/display readings, the analog output does not need to be readjusted most of the times.

The analog output adjustment is done via the frontal keypad. The analog output value is adjusted related to the display indication. This allows the intelligent use of the correction functions for offsets and fast

in case of trouble with the input signal, such as loop break or sensor break, the analog output signal will exhibit always the same behaviour predefined by the operator on the menu.

Voltage Output

Terminal 12 (Negative)
Terminal 13 (Positive)

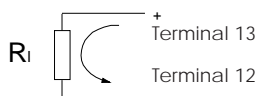

Current Output Source type (Active)

Terminal 13 (Negative)
Terminal 14 (Positive)

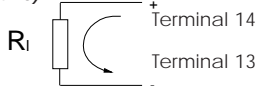

Current Output Sink type (Passive)

Terminal 12 (Negative)
Terminal 13 (Positive)

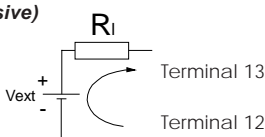

Note .- Sink Current set-up needs external power supply

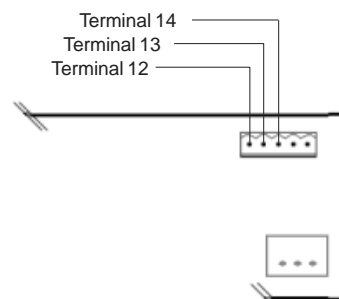

Technical Data

Output Signals	0/10 Vdc, 0/20 mA and 4/20 mA (and others)
Resolution	12 bits
Accuracy	<0.1% FS
Ripple	<0.01% FS
Thermal Drift	100 ppm/°C
Pass Band	1.5 Hz (-3 dB)
Response Time	250 ms (99% of indication)
Isolation Levels	2KVe _{ff} (50 Hz, 1 minute)

mA Output	RLmax	500 Ohms (Source Mode)
	Imax	21.5 mA aprox.
	SINK Output	maximum 40Vdc on terminals

Vdc Output	RLmin	1 KOhm
	Vmax	11 Vdc aprox.

Jumpers to the left.-
Output in Vdc

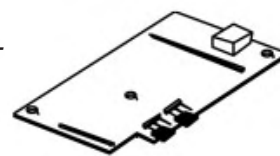

Jumpers to the right.-
Output in mA



Start-Up procedure

- 1.- Place jumpers on TSAT board for Vdc or mA output
- 2.- Plug the TSAT board on the bus pins (Expansion Bus) on board AL2 or EXP
- 3.- To configure the analog output you need to know the analog output signal and the related display indication

Input Signal	Indication	Analog Output
4 mA	0	0 Vdc (00000 milliVolts)
20 mA	100.00	10 Vdc (10000 milliVolts)

Note .- Analog output units are entered with 3 decimals, this is, in milliVolts and microAmperes.

- 4.- Make connections, power the unit and configure the board (see next page)

Entering the Menu

Introduce the programming code «55 11»
 Message «IC ANG» Analog Output board recognized
 Message «MENU» Entering the programming menu
 Message «4_20» or «0 10» Shows the operating mode selected by jumpers (Vdc or mA)

Adjusting the Analog Output

*Note .- The values for the following 4 parameter are settable using keys 1,2,3,4,5

- Parameter «d_LO» Display value for the low analog output signal (Display Low)
- Parameter «o_LO» Analog output value for the «d_LO» value* (Output Low)
- Parameter «d_HI» Display value for the high level analog output (Display High)
- Parameter «o_HI» Analog output value for the «d_HI» value* (Output High)

Note .- values for «d_LO» and «d_HI» are in microVolts or microAmperes

Behaviour when Error

- Parameter «OnErr» .- Behaviour when an «error» occurs
 - «DIR» Analog Output up to Full Scale (11Vdc or 21mA aprox)
 - «INV» Analog Output down to zero (-0.5 Vdc or 0mA aprox)

Note .- see section 4.11 for a description on «error» conditions

Exiting the Menu

Message «INPUT» Confirms that the parameters have been accepted

Message «ERROR» Informs that at least one of the values is not correct, and the whole configuration could not be applied. Repeat the process from the beginning.

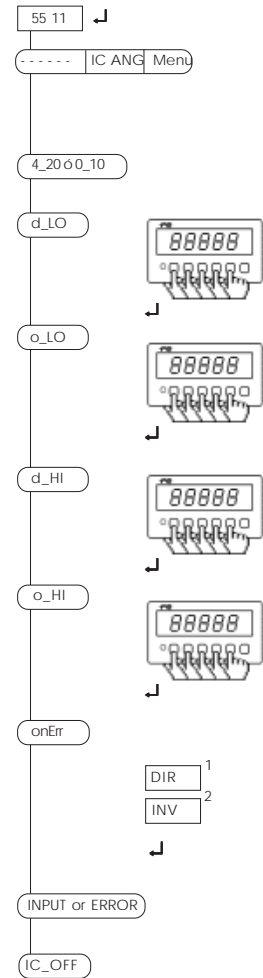

7.3- MODBUS OUTPUT - R485M OPTION BOARD

The R485M board adds Modbus communication capabilities to the TAS-1 units, for retransmission of visualized data to a remote element. The board is isolated and is completely configurable from frontal keypad.

Protocols Bus ModBus RTU and ModBus ASCII selectable
RS485 Half Duplex (EIA-RS485) shielded twisted pair cable, in line, closed with terminator

Speed 2400, 4800, 9600, 19200, 38400 bauds

Addresses from 0 to 99

Distances 1200 meters per BUS segment
4800 meters with repeaters

Isolation 2 KV with input signal
3.5 KV with power signal

Accepted Functions [04] H Register Read
(«Input Register» in the standard)

Register Map [00 00] H value on display
Type Integer
Value from -32768 to 32768

[00 01] H Decimal Point position
Type Integer
Value 0, 1, 2, 3, 4
0= No decimal point
1 = 1 Decimal
2 = 2 Decimals
3 = 3 Decimals
4 = 4 Decimals
5 = 5 Decimals

[00 02] H Instrument Status
Type Integer

Word composed fo 5 bits (1+4 bits)
b0=0 register [00 00]H is valid
b0=1 register [00 00]H is not valid

b4,b3,b2,b1
0 = Reserved
1 = Low
2 = -Ovr
3 = +Ovr
4 = DErr0
5 = Brk
6 = Con
7 = Open
8 = MErr0
9 = MErr1
10 to 15 = Reserved

Not Used	b4	b3	b2	b1	b0
----------	----	----	----	----	----

[00 03] H Alarms
Type Integer
b0 = 0 / 1 AL1 is OFF / ON
b1 = 0 / 1 AL2 is OFF / ON
b2 = 0 / 1 AL3 is OFF / ON
b3 = 0 / 1 AL4 is OFF / ON

Not Used	b3	b2	b1	b0
----------	----	----	----	----

Note1 : If there is no numeric value on display (but a text value), register 0000Hex offers value 32767 or -32768. And bit b0 of register 0002Hex show the display status.

Note2 : The length of all registers is 2 bytes, defined as LSB and MSB. MSB (Most Significant Byte) is the first to be transmitted. LSB (Least

Configure MODUBS output

Introduce te programming code «55 11»
Message «IC 485» RS485 board recognized
Message «MENU» Entering the programming menu

Parameter «PROT» Protocol
Select Modbus ASCII or Modbus RTU

Parameter «DIR» Address
Input instrument address

Parameter «BAUDS» Speed in Bauds

Parameter «n BIT» Number of Bits
Select 8 or 7 bits per character

Parameter «t PAR» Parity
«Even» «Odd» «nPar»

Message «INPUT» .- confirms that the parameters have been accepted

Message «ERROR» .- informs that at least one of the values is not correct, and the whole configuration could not be applied. Repeat the process from the beginning.

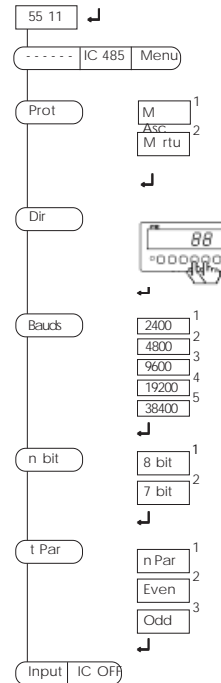

RTU and ModBus ASCII

	START	DATA	PARITY	STOP	TOTAL BITS
RTU	1	8	P	1	11
	1	8	I	1	11
	1	8	--	2	11
ASCII	1	7	P	1	10
	1	7	I	1	10
	1	7	--	2	10

Frame Structure

QUESTION : Communication MASTER and SLAVE

ADDRESS	1 CHARACTER	Instrument Address
FUNCTION	1 CHARACTER	Function 04H, register read
READING START REGISTER	2 CHARACTERS	Register 00 00H = Display Value
NUMBER OF REGISTERS TO READ	X CHARACTERS	02 = 2 registers (4 bytes)
CRC	2 CHARACTERS	Control Checksum

RESPONSE : Communication SLAVE to MASTER

ADDRESS	1 CHARACTER	Instrument Address
FUNCTION	1 CHARACTER	Function 04H, register read
LENGTH	1 CHARACTER	Number of data characters following
DATA	X CHARACTERES	Response data*
CRC	2 CHARACTERES	Control Checksum

7.4- PEAK, VALLEY, HOLD, TARE, RESET- OPTIÓN TEK

The TEK option adds functions for PEAK/VALLEY memory, or remote TARE or remote HOLD to the instruments TAS-1. These functions are selectable and programmable from frontal keypad, and are activated connecting two external contacts to the rear side terminals. Each contact has assigned

one function (which can be changed) plus a third function associated to both contacts closing at the same time, to release a RESET for PEAK/VALLEY memory. Isolated option.

Functions	PEAK	Contact1	Contact2
	PEAK	YES	YES
	VALLEY	YES	YES
	HOLD	YES	YES
	TARE	YES	NO
	RESET	YES	NO

Terminal 12 .- COMMON
Terminal 15 .- CONTACT1
Terminal 16 .- CONTACT2

Note .- the function assigned to Contact1 and Contact2 are configurable from frontal keypad.

Note .- «TEK» board can be configured to release a «RESET» of the «PEAK» and the VALLEY values when both Contact1 and Contact2 are simultaneously closed.

Isolation Levels 2KV to the input signal
3K5V to the power 230Vac and 115Vac
1KV to the power 24Vdc

Entering the Menu

Introduce the programming code «14 23»
Message «E INP» TEK board recognized

Configuring the external contacts

Parameter «INP_1» Contact 1
ON Active
OFF Not Active

Parameter «FUN_T» Function assigned to Contact1

Parameter «INP_2» Contact 2
ON Active
OFF Nor Active

Parameter «FUN_T» Function assigned to Contact2

Parameter «RES12» RESET12
Function «Reset» when connecting contacts 1 and 2 simultaneously
ON Active
OFF Nor Active

Exiting the Menu

Message «INPUT» .- confirms that the parameters have been accepted

Message «ERROR» .- informs that at least one of the values is not correct, and the whole configuration could not be applied. Repeat the process from the beginning.

Default Configuration

When entering code «14 22» to apply a unit reset, the TEK option is configured as follows :

	STATE	FUNCTION
CONTROL 1	OFF	HOLD
CONTROL 2	OFF	HOLD
CONTROL 12	OFF	

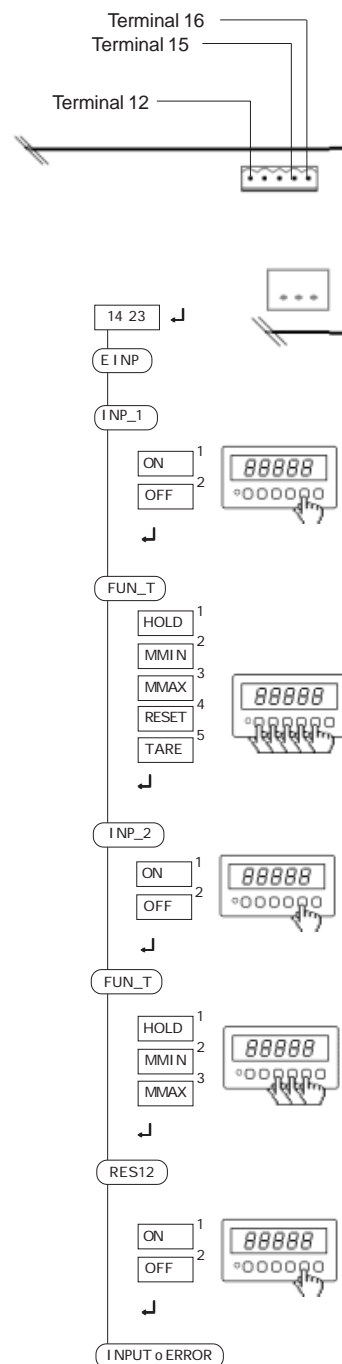

DECLARATION OF CONFORMITY CE

Manufactured by: FEMA ELECTRONICA, S.A.
Address: P.I. Santiga
 Altimira 14 (Talleres-14, Nave-2)
 08210- Barberà del Vallès (Barcelona-Spain)

Declares that the equipment complies with the following technical specifications.

Product: TAS-TP, TAS-VDC, TAS-VAC, TAS-IDC,
 TAS-AC

DIRECTIVES

EUROPEAN DIRECTIVE FOR LOW VOLTAGE D73/23/CEE AMENDED BY D93/68/CEE.
 Equipments powered from 50 to 1000 Vac. and/or from 75 to 1500 Vdc.

EUROPEAN DIRECTIVE FOR PRODUCT SAFETY D92/59/CEE.
ELECTROTECHNICAL REGULATION FOR LOW VOLTAGE (RBT) ITC 21, ITC 29, ITC 35. For equipments with power supply lower than 50 Vac and/or 75 Vdc.

EUROPEAN DIRECTIVE FOR ELECTROMAGNETIC COMPATIBILITY D89/336/CEE AMENDED BY D93/68/CEE, ACCORDING TO RD1950/1995 (Dec.1st).

REGULATIONS

ELECTRICAL SECURITY: EN 61010-1
SUCEPTIBILITY: EN 50082-2
 IEC 1000-4-2, EN 61000-4-2, IEC 801-2
 ENV 50140, EN 61000-4-4, IEC 801-4 (level 3)
 ENV 50141, IEC 801-3 (level 3)
 ENV 50204 (level 3)

EMISSION: EN 50081-2,
 EN 55011, EN 55014, EN 55022

UNE 21352-76: CEI 359-71.
 Operating quality expressions for electronic equipments.
UNE 20652-80: CEI 284-68.
 Behaviour rules inherent to the handling of electronic equipments and other similar technics.

FEMA ELECTRONICA, S.A.
 Barberà del Vallès, 2000

WARRANTY.

FEMA ELECTRÓNICA, S.A. warrants this product free of manufacture defects for two years from the date of shipment.

This Warranty is VOID if the unit shows evidence of damages as a result of misapplication, accident, misuse or if the product has been tampered or repaired by personnel or companies without the official authorization of FEMA ELECTRÓNICA, S.A. This Warranty is VOID also for damages caused by defective or inappropriate applications.

During the warranty FEMA ELECTRONICA, S.A. will repair or replace at its own discretion the material which results to be faulty. Attach with the material a copy of the invoice and delivery note, with a description of the malfunction, and ship it free of charge and properly packed to your local distributor or to the following address

FEMA ELECTRONICA, S.A.
 Altimira 14 (Talleres-14, Nave-2)
 P.I. Santiga
 E 08210 BARBERÀ DEL VALLÈS
 BARCELONA (SPAIN)

LIMITATION OF LIABILITY

FEMA ELECTRONICA, S.A. shall not be responsible for any damage or loss to other equipment however caused, which may be experienced as a result of the installation or use of this product. FEMA ELECTRONICA, S.A. liability shall not exceed the purchase price paid of the product upon which liability is based. In no event shall FEMA ELECTRONICA, S.A. be liable for consequential, incidental or special damages.

INSTALLATION

PRECAUTIONS.- Installation and use of this unit must be done by qualified operators. The unit has not AC (mains) switch, neither internal protection fuse, and it will be in operation as soon as power is connected. The installation must contain an external mains switch with protection fuse plus the necessary devices to protect the operator and the process when using the unit to control a machine or process where injury to personnel or damage to equipment or process may occur as a result of failure of the unit.



External Protection Fuse to be added :

for 230 Vac : **80mA fuse TimeLag** as IEC 127/2
 for 115 Vac : **125mA fuse TimeLag** as IEC 127/2

SAFETY PRESCRIPTIONS.- These instruments have been designed and tested according to EN-61010-1 rules and are delivered in good operational conditions. This user manual contains useful information for electrical connections. Do not make wiring signal changes or connections when power is applied to the unit. Make signal connections before power is applied and, if reconnection is required, disconnect the AC (mains) power before such wiring is attempted. Install the unit in a place with good ventilation to avoid excessive heating, and far from electrical noise sources or magnetic field generators such as power relays, electrical motors, speed controls etc...



The unit cannot be installed in open places. Do not use until the installation is finished.

POWER SUPPLY.- The power supply must be connected to the adequate terminals (see connection instructions). Characteristics of the power supply are showed on the characteristics label attached to the instrument. Please make sure the unit is correctly connected to a power supply of the correct voltage and frequency. Do not use other power supply otherwise permanent damage may be caused to the unit. Do not connect the unit to power sources heavily loaded or to circuits which power loads in cycle ON-OFF or to circuits which power inductive loads.

WARNING.- On units with DC power supply, be careful with the polarity indicated for each terminal.

SIGNAL WIRING.- Certain considerations must be given when installing the signal input wires. Long wires can act like an antenna and introduce electrical noise to the unit, therefore :

Do not install the signal input wires in the same conduct with power lines, heaters, solenoids, SCR controls etc...and always far from these elements.

When shielded wires are used, leave unconnected the shield on the indicator side and connect the other end of the shield to the ground terminal of the machine.

SAFETY CONSIDERATIONS

PRESCRIPTIONS.- Before starting any operation of adjustment, replacement, maintenance or repair, the unit must be disconnected from any kind of power supply.



Keep the unit clean , to assure good functioning and performance. To prevent electrical or fire hazard, do not expose the unit to excessive moisture. Do not operate the unit in the presence of flammable gases or fumes, such as environment constitutes a definite safety hazard. The unit is designed to be mounted on a panel.

If the unit shows signs of damage, or is not able to show the expected measures, or has been stored in a bad conditions or a protection failure can occur, then do not attempt to operate and keep the unit out of service.
IN CASE OF FIRE

IN CASE OF FIRE



- 1.- Disconnect the unit from the power supply.
- 2.- Give the alarm according to the local rules.
- 3.- Switch off all the air conditioning devices.
- 4.- Attack the fire with carbonic snow, do not use water in any case.

WARNING : In closed areas do not use systems with vaporized liquids.