

**THE UNIVERSAL CABINET CONCEPT
FOR THE WORLD OF ELECTRONICS**

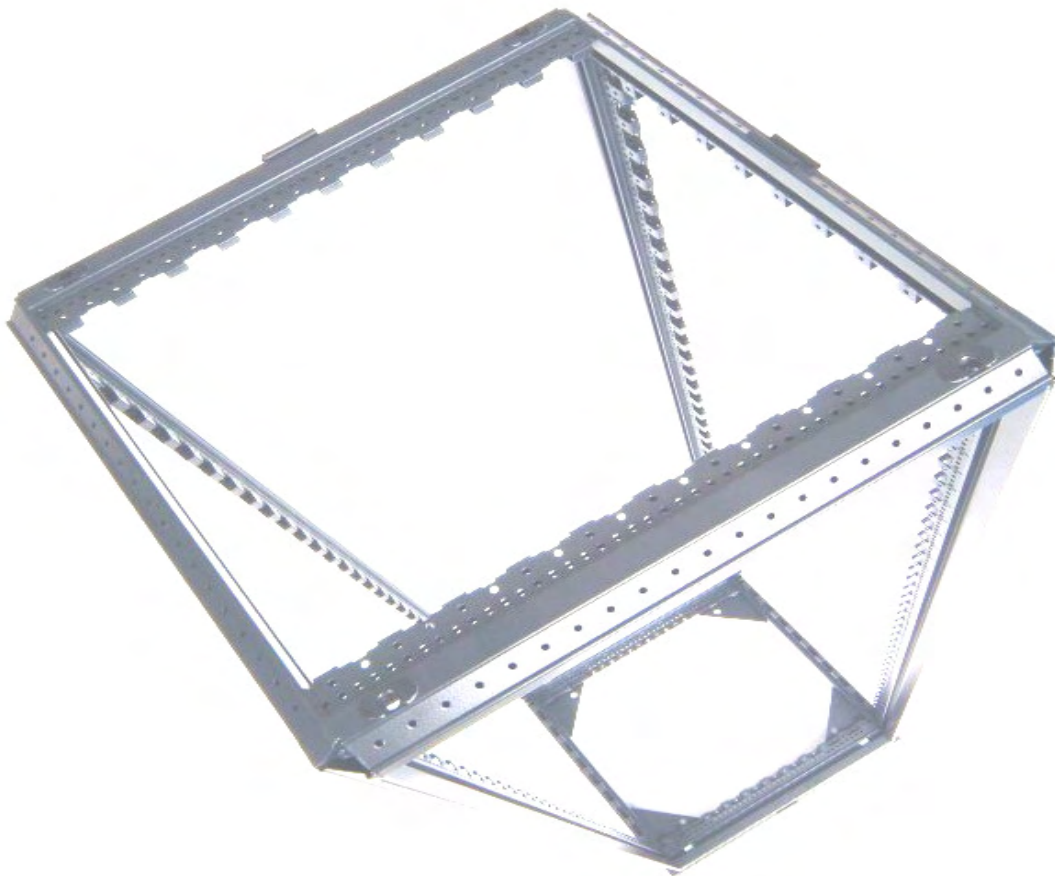

Contents

1. INTRODUCTION.....	3
1.1 Cabinet Dimensions.....	3
1.2 Static and Dynamic Capacity.....	3
1.3 Electromagnetic Shielding.....	3
1.4 Seismic Tests.....	3
2. DESIGN.....	4
3. DIMENSIONAL STANDARDS.....	5
4. CLIMATIC, MECHANICAL TEST AND SAFETY ASPECTS ACCORDING TO IEC 61587-1, THERMAL MANAGEMENT.....	6
4.1 Climate, Industry Atmosphere.....	6
4.2 Thermal Management.....	6
4.3 Mechanical Tests.....	11
4.3.1 Lifting Tests.....	11
4.3.2 Stiffness of the Cabinet Structure Test	11
5. DYNAMIC MECHANICAL TESTS.....	12
6. SAFETY ASPECTS UND ROHS DESIGNATIONS.....	13
6.1 Protective Earthing.....	13
6.2 Flammability.....	13
6.3 Protection against dust and water.....	13
7. ELECTROMANETIC SHIELDING.....	14
8. SEISMIC TESTS.....	15
9. SUMMARY.....	16
10. SCHROFF CORPORATE PICTURE, ABOUT THE AUTHOR.....	17

1. INTRODUCTION

With a universal cabinet concept one can understand the modular compatibility and cabinet accessories for rack mounting according to international standards (IEC). In contrast to simple construction for constrained standards, a global concept must offer a selection for users with specific configurations from of the modular assembly system. These characteristics significantly influence the logistics, like the timely implementation of projects.

The latest development of electronics in conjunction with stronger regulations regarding universal compatibility, places higher demands on the materials, the efficiency of the electronic and mechanical protection functions, and the thermal management, like the mechanical robustness regarding shock, vibration, and seismic applications.

1.1 Cabinet Dimensions:

- What components should be integrated into the cabinet?
- 19" or metric?
- Is room for cabling needed?

1.2 Static and Dynamic Capability:

- How much of a load can the cabinet hold while stationary?
- Can the cabinet be moved or pushed after the integration?
- Is there a different dynamic capability during the transportation of the cabinet to its installation location?
- Is the cabinet shock and vibration influence set out? For example...
 - in the vicinity of a rotating machine?
 - near a railway or street signal?
 - on a ship?

1.3 Electromagnetic Shielding:

- Is shielding of the equipment necessary?
- What are the critical interference frequencies?
- How high should the shielding be?

1.4 Seismic Tests:

- Is the installation location in a seismic zone?
- For which seismic zone should the cabinet be designed?
- What is the highest static load?

These specifications and essential test procedures will be described in the following pages to specify the development of a cabinet. The above specifications will be clarified in relation to electronic cabinet platform VARISTAR from Schroff.

2. DESIGN

Meander Profile

Varistar is based on welded frame constructed from closed section rolled steel profiles.

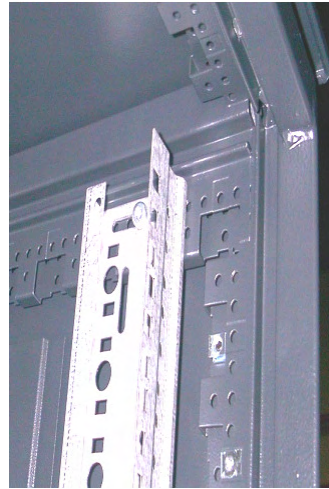

Two profiles with different sections are for two important requirements:

SLIM-LINE is the smaller profile and is used for frames that fall under the IEC 61587-1 with load to 400 kg. SLIM-LINE frames offer the maximum internal width so 19" components according to IEC 60297-3-100*, and „hard metric“ IEC 60917-2-2 and respectively ETS 3001 119-2/ 3 can be placed within the frame.

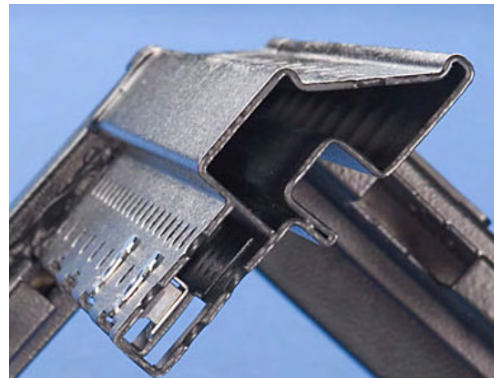

HEAVY-DUTY is the larger profile and can withstand heavier loads. The higher stiffness follows the definition in IEC 61587-1 with load to 800 kg. With the same outer measurements as the SLIM-LINE, the inner width is smaller and therefore intended for the use of 19" components according to IEC 60297-3-100* only.

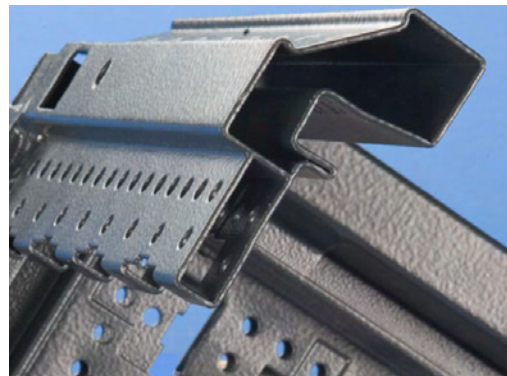

* IEC 60297-3-100 the projected replacement for IEC 60297-1 and IEC 60297-2.

3. DIMENSIONAL STANDARDS

Three defined dimensions for the cabinet:

IEC 60297-3-100 (19 inch Standard)

IEC 60917-2-2 (25mm metric Standard)

ETS 300 119-2/-3 (European Telecommunication Standard)

With the same outer measurements the HEAVY-DUTY and SLIM-LINE cabinets are differentiated by their internal clearance widths and by their accessories.

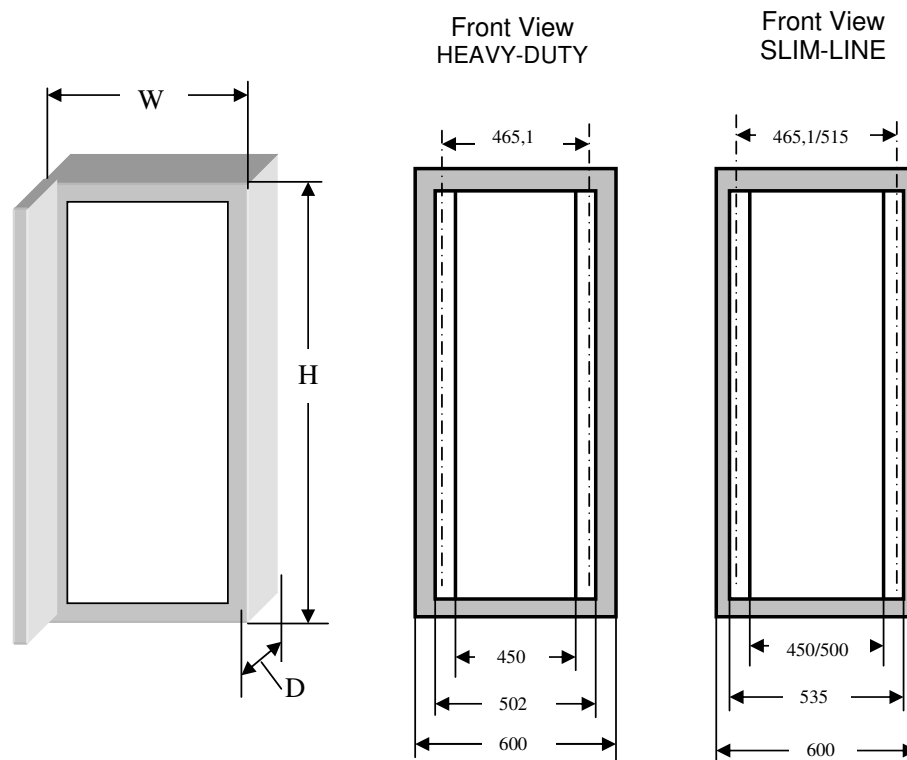

Figure 1:
Assembly dimensions for HEAVY-DUTY and SLIM-LINE

Front view dimensions are defined.

(Missing dimensions are detailed in the above quoted standards)

4. CLIMATIC, MECHANICAL TESTS AND SAFETY ASPECTS ACCORDING TO IEC 61587-1, THERMAL MANAGEMENT

4.1 Climate, Industry Atmosphere

The goal of the climatic tests is for safeguarding the reliable serviceability of the cabinets in their operating environment.

The construction elements of VARISTAR follow the classification requirements C 3 and A 3 according to IEC 61587-1:

- C 3: Temperature range -40°C to +85°C
- A 3: Heavy concentration of harmful substances 25 cm³/m³ SO₂, 15 cm³/m³ H₂S, 5% NaCl

4.2 Thermal Management

The most frequent reason for operating failures in electronic devices built into cabinets is thermal overload. In project design components must be near an open area, and cabling is respected by the dimension of convenient cooling measures. Inner temperatures and outer temperature required for the planning of open rooms with adequate cooling throughout regardless of the important parameters such as power dissipation. If the open room is too small then the attainment of required air volumes with high air speeds is necessary to cool, which could create objectionably high noises. For this it is advisable to operate according to IEC 62454. After this it is possible to choose the most practical system for the allowed inner temperatures of the devices.

Cooling Concept Overview

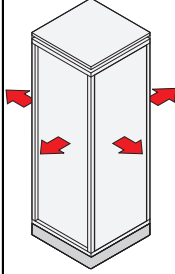
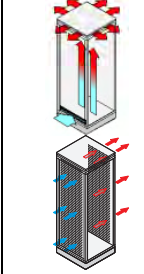
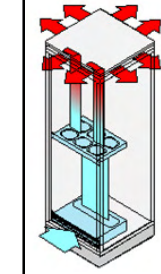
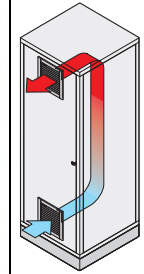
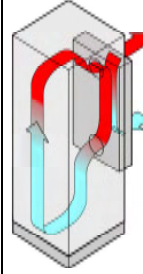
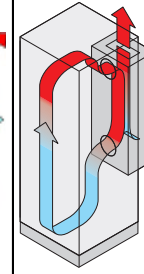
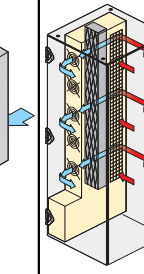
Description	Passive Cooling, Thermal Radiation	Passive Cooling Free Convection	Active Cooling with Air	Active Cooling with Air	Active Cooling with Aid	Active Cooling with Aid	Active Cooling with Water (closed system)
Cooling Concept							
Product	Closed Cabinet	- Perforated Doors - Air slots - Raised Top Cover	- 19" blower units - top cover with fans	Filter Fan	Air/Air Heat Exchanger	Climate Device	Air/Water Heat Exchanger (Varistar LHX 20)
Protection type	≥ IP 20	≥ IP 20	≥ IP 20	≤ IP 54	≥ IP 54	≥ IP 54	≥ IP 54
Noise Level	0	0	34...67dB(A)	39...71dB(A)	55...75dB(A)	60...81dB(A)	50...60dB(A)
Environmental Conditions	T _i > T _A	T _i > T _A	T _i > T _A	T _i > T _A	T _i > T _u	T _i ≤ 35°C	T _i ≥ 20°C
Location	Office or Industry	Office or Industry	Office or Industry	Industry	Industry	Industry	Office or Industry
approx. Cooling Capacity #	< 500 W	500 W ... 1000 W	< 2000 W	< 1500 W	< 2000 W	≤ 3000 W	≤ 20000 W
T _i = Cabinet Temperature T _A = Ambient Temperature							

Passive Cooling

The passive cooling of a cabinet is based merely on the radiation from the surfaces in the environment. As a result a temperature grade for inner and outer temperatures must always be present. The radiating surfaces can be calculated with the rule of thumb 5W per m² per k (Δ T), under the assumption that the warm air inside is evenly distributed. Therefore, a cabinet 2m high, 600 mm wide and 600 mm deep (approx. 5m² effective surface) can be calculated to have a Δ T of 10k (T_i zu T_A) with a heat emission of approx. 250 W (5 x 5 x 10).

Active Cooling

With active cooling with fans the air volume is critical according to the dimensions of the air passages and the air volume over the devices. This allows the necessary air volume to get to the components and not to exceed the prescribed noise level. As a rule of thumb, with an air volume of 3.3 m³/h the temperature at a power dissipation loss of 1W increases by 1k. So with a power dissipation of 1000W and a temperature increase of 10°k an air volume of 3.3 x 1000/10 = 330 m³/h is necessary.

Active Cooling with Aid

With active cooling which is supported by heat exchangers or climate control units the air volume has to be calculated for the particular equipment. After that the performance value of the equipment is entered, whereby the temperature rise of the equipment is calculated.

When in the previous example a compressor driven cooling unit is used, the cooling performance depends on the corresponding internal temperature in relation to the outer temperature, which to DIN 3168 is given as ΔT_i to T_A of 35° C to 35° C and 35° C to 50° C. Therefore with the use of a cooling unit with 1000W cooling performance (specified at $T_A=50°$ C) the cooling temperature of the installed equipment is a constant 35° C.

Active Cooling with Water according to IEC 62454

Level I- Cabinet levels in IEC 62454 describes framework conditions and details calculated examples for applications with Air/Water Heat exchangers that are assembled in either in the base or on the side of the cabinet. These options allow the air/water heat exchanger to generate two basic air flow possibilities: vertical or horizontal.

With vertical air flow the air circulates over the Cabinet height. The heat exchanger sits in the bottom of the cabinet and ducts the cold air from the front through the integrated components to the back where the air is ducted back over fans in individual subracks or fans in a heat exchanger. With horizontal airflow the cold air circulated over the total cabinet height from front to the back through the integrated components. The heat exchanger is positioned on the side in this case.

Regardless of which solution one chooses (base or side assembly), the operator can determine either with the help of a diagram or the calculation from formulas for the application of necessary footprints. The defined dimensions of the integrated components are 400mm in depth and 600mm in cabinet width.

The benchmark for the calculation of necessary cabinet depths is the ΔT between the inside of the cabinet and the ambient temperature in Kelvin as well as the expected cooling capacity, Q, in kW.

Figure 2:

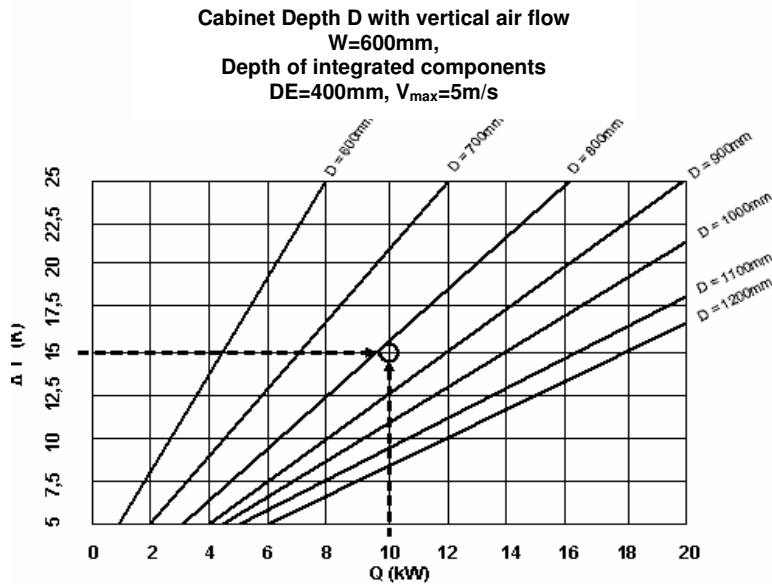
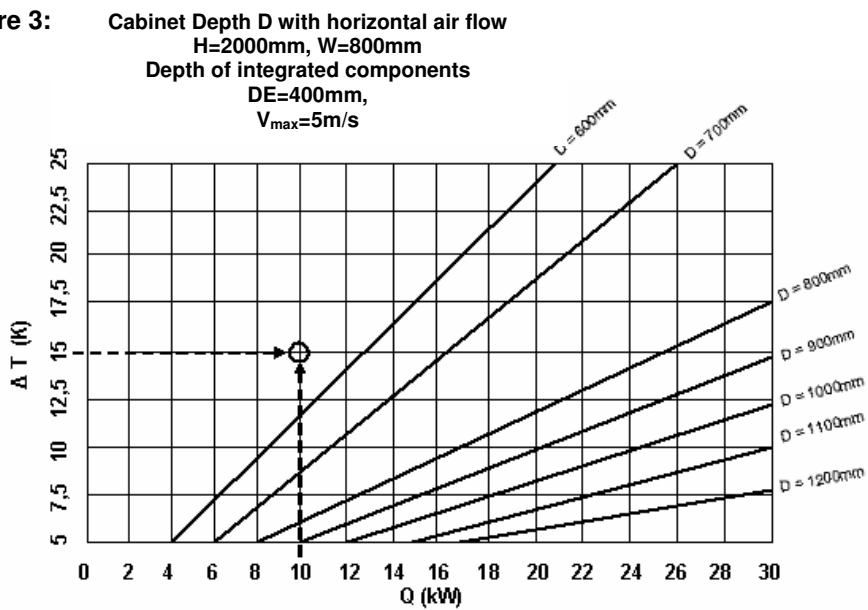
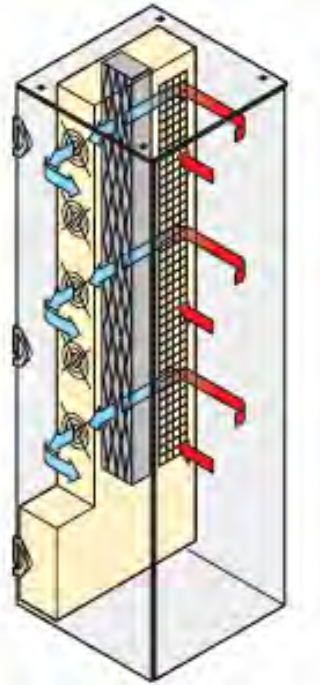
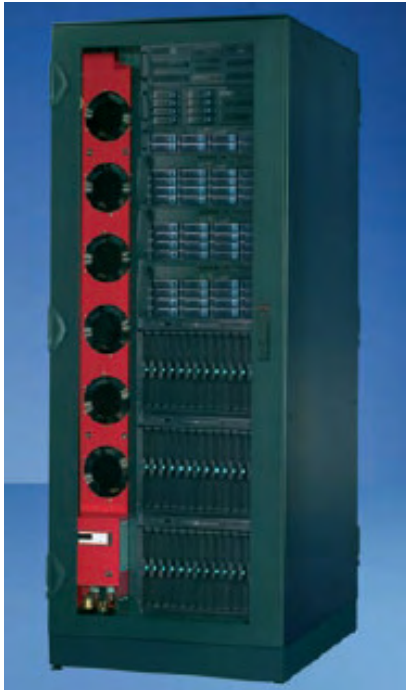

Figure 3:



White Paper – The universal cabinet concept

A cabinet with horizontal air flow, in comparison to a vertical air flow, needs a smaller depth when all other measurements are equal. Therefore regardless of higher cooling capacities a small footprint can still be obtained.



Schroff developed a complete cabinet cooling concept, VARISTAR LHX 20 that is totally independent of the room. The system is installed with a cooling capacity of up to 20kW. The Air/Water Heat Exchanger is a complete unit that can be inserted on either the left or the right side of the cabinet and has horizontal air flow. Therefore, the entire height of the 19" section (42U) of the cabinet is usable. The heat exchanger resides as a closed air circuit in the cabinet and can handle an air volume of up to 3000 m³/h. Air circuit elements and six fans on the side of the cabinet ensure that the cabinet is evenly cooled throughout all of the integrated components. Cold water runs through an external water circuit and through the heat exchanger where it is warmed and then flows back to the chiller. Here the water is cooled back to the desired temperature.

4.3 Mechanical Tests

The goal of the mechanical test is to safeguard the cabinet so that it can withstand loads through transportation, storage, and operation.

For the assessment, all mechanical tests are controlled that no subsequent changes are allowable if they can influence function and safety.

4.3.1 Lifting Test

The lifting test determines the stability of the cabinet structure and the anchoring of the lifting-eyes. To test, the cabinet is bolted to the floor and the lifting device should be perpendicular from the lifting-eyes (See Table 1).

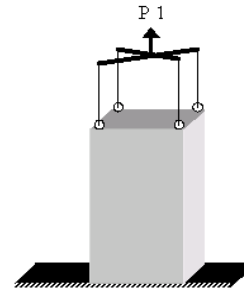

4.3.2 Stiffness of the Cabinet Structure Test

This test determines the durability of the cabinet structure under the influence of transportation and operation. To test the cabinet is anchored to the floor and the load P 2 is applied on the surfaces 100mm from the top edge of the cabinet (the test should be done from the front and sides, P 2 see Tabel 1).



Tabelle 1: Performance Level for Lifting and Stiffness

Cabinet Type	Performance Level	Nominal Load Kg	Lifting Test Force P 1 (N)	Stiffness Test Force P 2 (N)
SLIM- LINE	SL 6	400	6000	1000
HEAVY- DUTY	SL 7	800	12000	2000

Note: IEC 61587-1 states the load in relationship to the strength of the lifting and stiffness tests. This definition classifies the VARISTAR type. The stationary load of the cabinet, when it remains in one place, can be much higher and depend on fundamental reinforced accessories.

5. DYNAMIC MECHANICAL TESTS

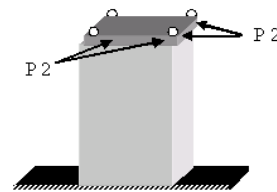
The dynamic mechanical tests simulate the environment effects on the intended installation locations as it would be during transportation. In order to generate realistic and reproducible results it is essential that the tests are followed according to size and configuration (see figure 4).

The load will be simulated with cases/subracks, 5 pieces 10kg each (M 3) in total. In the lower cabinet area an undefined load of 100kg (M4) is installed. Assembly aids, such as mounting rails or guide rails, can be used. The tested cabinet should be bolted to the vibration and shock table. The standards and application area are described in Table 2.

The assessment of the test results should be carried out according to the 4.3 description.

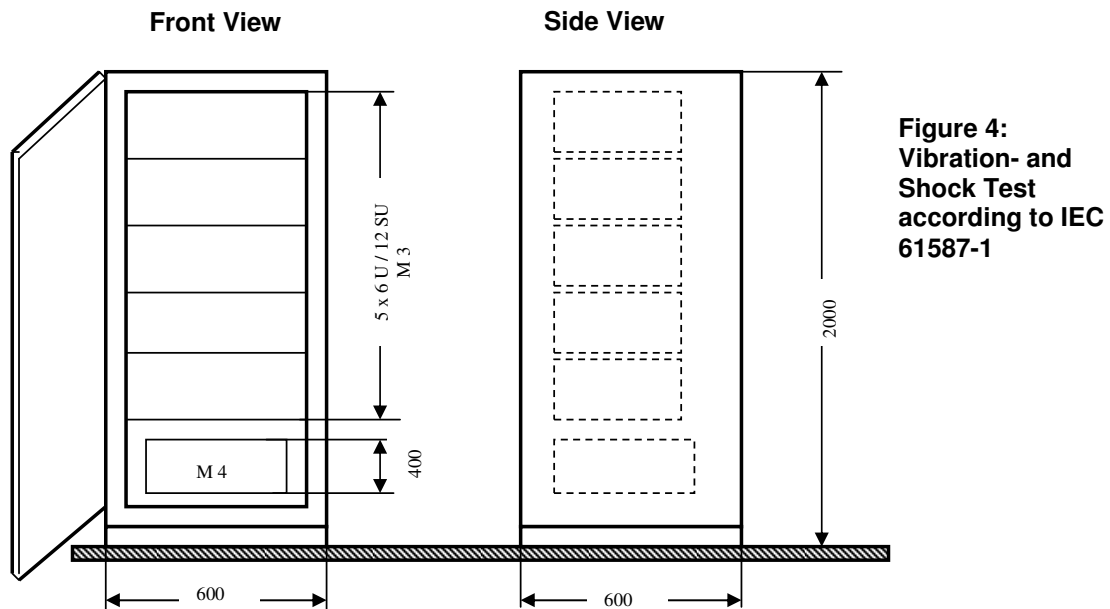

Figure 4:
Vibration- and
Shock Test
according to IEC
61587-1

Tabelle 2: Regulated Range for vibration and shock test

Cabinet Type	Range	Application Area	Vibration Test		Shock Test
			Frequency Hz	Deflection Amplitude mm	Acceleration Amplitude m/s ²
SLIM-LINE	DL 5	Moderate level of shock and vibration, stationary and mobile use. Loaded cabinet for railway, motorway signalling applications, close to rotating machines	2 to 9	3,0	-
			9 to 200	-	10
HEAVY-DUTY	DL 6	High level of shock and vibration Applications such as commercial ships- low level military requirements	5 to 9	7,0	-
			9 to 200	-	20

6. SAFETY ASPECTS AND ROHS DESIGNATIONS

The VARISTAR cabinet series was developed and manufactured under international standards. The specific requirements of the IEC 61587-1 affect cabinets of 482.6 mm (19 in), construction according to IEC 60297-3-100, as well as 25mm (metric) construction according to IEC 60917-2-2. As a result, global safety aspects are fulfilled according to IEC 60950 and the material conditions of ROHS designations.

6.1 Protective Earthing

The protective earthing of VARISTAR is star-point with central earth connections. The resistance to the individual parts is less than 0.1 Ohm.

6.2 Flammability

This standard basically refers to synthetics. Plastic material, which is used on the VARISTAR for locks, handles, seals and accessories, complies with the self extinguishing class V 0 according to UL 94 (IEC 60695-2-2). Thereby, the requirements follow ISO 14000 in which no more than the necessary substances are self extinguishing so that production and later recycling does not have material that is harmful to the environment.

6.3 Protection against Dust and Water

VARISTAR is specially protected against dust and water. The protection type IP 55 according to IEC 60529 is guaranteed especially on the doors through locking so each cabinet height can be placed. Through this a very consistent compression of the gaskets is guaranteed, which also has low closing power of the handles.

7. ELECTROMAGNETIC SHIELDING

The shielding against electromagnetic influence is a fundamental requirement for the attainment of electromagnetic compatibility with cabinet. VARISTAR can be assembled with conductive textile gaskets, which connect all enclosure covers without gaps. Contrary to conventional methods where the EMC gaskets are put on the enclosure covers and contact one another over a conductive coating, the VARISTAR concept has technical and economical advantages. The typical shielding effectiveness is depicted by the smooth curve in figure 6. VARISTAR fulfils requirement 3 according to IEC 61587-3 with 40 dB at 2GHz.

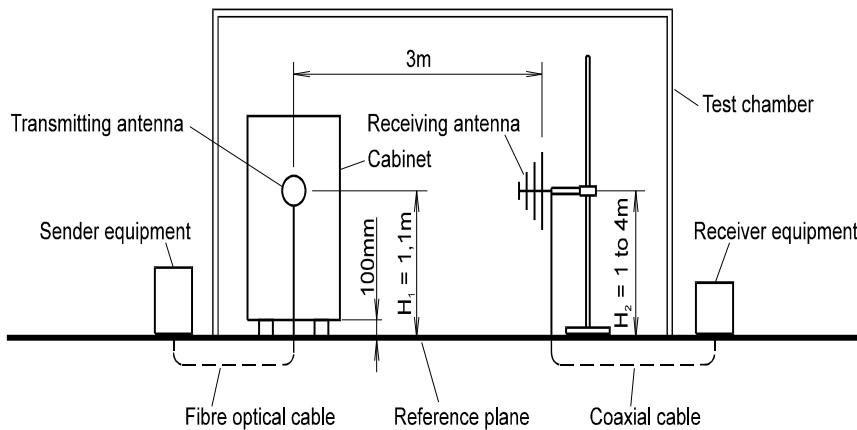

Figure 5: Set-up for measurement of the shielding

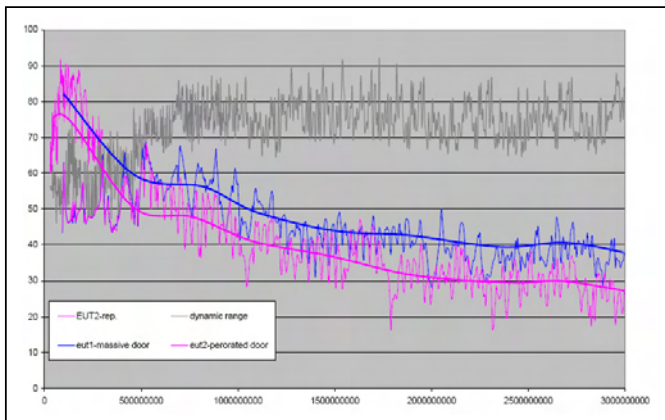

Figure 6: Shielding Curve
 — Cabinet with closed door
 — Cabinet with perforated door

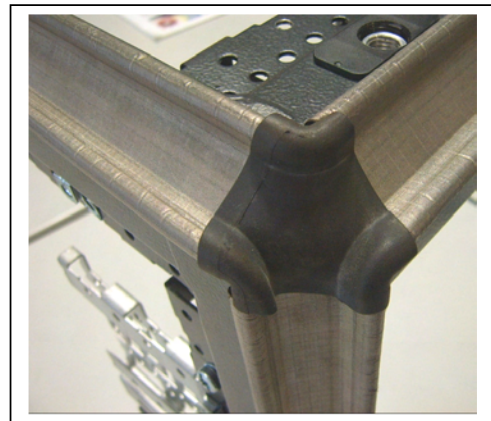

Figure 7: Conductive Textile Gasket

8. Seismic Tests

VARISTAR is constructed for high mechanical loads. Therefore the stiffness of the frame is crucial. VARISTAR SLIM- LINE and HEAVY- DUTY are constructed to withstand an earthquake, onto which additional bracing contributes to the improvement of the cabinet's stiffness. According to IEC 61587-2, a test construction should allow for seismic requirements. In order to obtain realistic and reproducible results the test needs to follow the size and classifications described (see figure 11). The construction is simulated with cases/subracks, 4 pieces in total with 25kg each (M3) and one piece with 60 kg (M5). An undefined load of 90 kg is installed into the bottom of the cabinet. Assembly aids, such as mounting rails or guide rails, can be used. The tested cabinet should be firmly bolted to the test table for the duration of the earthquake-test. The assessment of the test results should be carried out according to the 4.3 description.

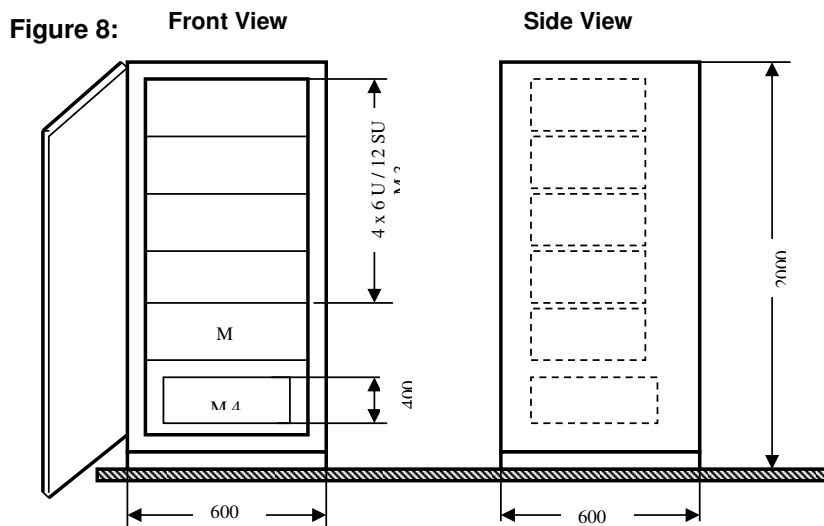
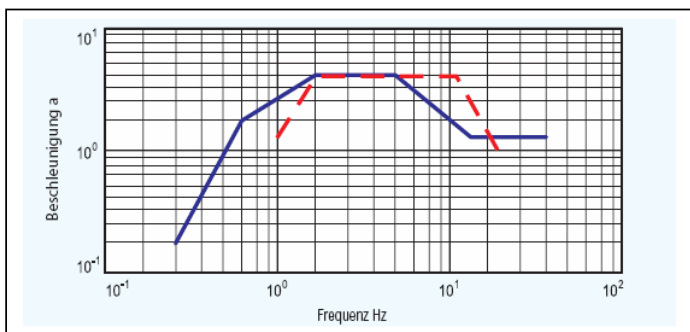

Figure 9: Seismic test according to IEC 61587-2



The response spectrum according to waveform A (blue line) and B (red dashed line) according to IEC 61587-2

9. SUMMARY

The diverse applications in the electronic market segment demand a wide spectrum of technical requirements for cabinets. Dimensions, construction, static load, shock and vibration stability, EMC shielding, and seismic stability are important criteria for cabinet specifications. These characteristics are set by the tests and their described standards, which serve as a guideline for development.

A universal cabinet platform, like the VARISTAR, satisfies all these requirements with two different frames (Slim-Line and Heavy-Duty), a continuous electromagnetic shielding gasket concept, and a modular accessory program, which offers the customer cost advantages.

Global Application

The uses of a universal cabinet platform are especially clear for organizations with global distribution. Every location and project requires the user of the construction according to metric or inch standards (ETSI and/or 19 in.), mechanical robustness in an earthquake, electromagnetic shielding or solutions for cooling, or the combination of different requirements. All of these should be realized in the construction of the cabinet system. Variation reduction and with it simplified logistical processes lead to sparing costs.

10. SCHROFF CORPORATE PICTURE; ABOUT THE AUTHOR

[Schroff](#), with its headquarters in Straubenhardt / Germany is a leading developer and manufacturer of electronic packaging systems for technologies such as electronics, automation, IT and communication worldwide. The standard product range extends from cabinets, cases and subracks to power supplies, backplanes and micro computer systems. Utilising its product platforms Schroff is able to offer customized modifications in a fast and cost effective way. Its extensive integration service combines both products and services providing complete packaging solutions with a true customer benefit.

Schroff's products and services are the results of systematic and continuing focus on the global needs of the electronics markets over many years. By continuously strengthening the core competencies, it is able to provide customers with additional value through expertise in electronic packaging, thermal management and electromagnetic compatibility.

Buket Mansuroglu is a product manager for electronic cabinets at Schroff. After her studies in business administration with an emphasis in international management and controlling, she completed her Master of Science in International Business in London. After a two year trainingship with Schroff in different departments from Marketing and Product Development, she took responsibility of developing the concept of the cabinet platform Varistar in 2003.

Paul Mazura is Vice President Product Development at Schroff. His active duties in international standards (DIN, IEC, IEEE, VITA) lead to market-influenced product specifications. Therefore, special collaboration works on the series of standards of the 19" standard (IEC 60297 Series), the metric standard (IEC 60917 Series), as well as outdoor enclosures (61969 Series) and requirements and tests for construction standards (IEC 61587 Series).

With his years of industry experience in development and marketing of mechanical construction system, he sets directives for the successful teamwork in the developing of the VARISTAR cabinet platform.