

100mm Process Recorder

SR100B

- **3- or 6-trace recording on a 100mm chart**
 - common time base for instant process comparison
- **High clarity liquid crystal display**
 - for process value, units and channel tags
- **Universal process inputs**
 - accepts thermocouples with ACJC, RTDs, mA, mV and V
- **Available preconfigured to your requirement**
 - make connections and it's ready to go!
- **2-wire transmitter power supply as standard**
 - for up to three, loop-powered transmitters
- **Rugged design IP65/NEMA3, washdown protection**
 - reliability in the harshest environments
- **Six relay outputs**
 - for High/Low process alarms
- **PC Configuration**
 - for quick and easy setup on site



SR100B
– power without complexity

The ABB logo, consisting of the letters 'ABB' in a bold, red, sans-serif font.

100mm Process Recorder
SR100B

SS/SR100B_5

SR100B

The SR100B provides accurate and reliable recording of 3 or 6 process signals on a 100mm wide chart. In-built text printing capabilities give clear annotation on the chart of time, date, scales and channel identifiers.

A clear view of process status is provided by the liquid crystal display (LCD) display and up-to-the-minute recording can be quickly examined by means of the 'Easy View' facility. The recorder is designed for panel mounting and provides complete dust and water protection on the front face, making it suitable for use in harsh environments.

The SR100B can be supplied preconfigured for the signal types and ranges you specify when ordering. All configurations can be adjusted on site by means of the front panel keys or a PC Configurator.



Process Connections

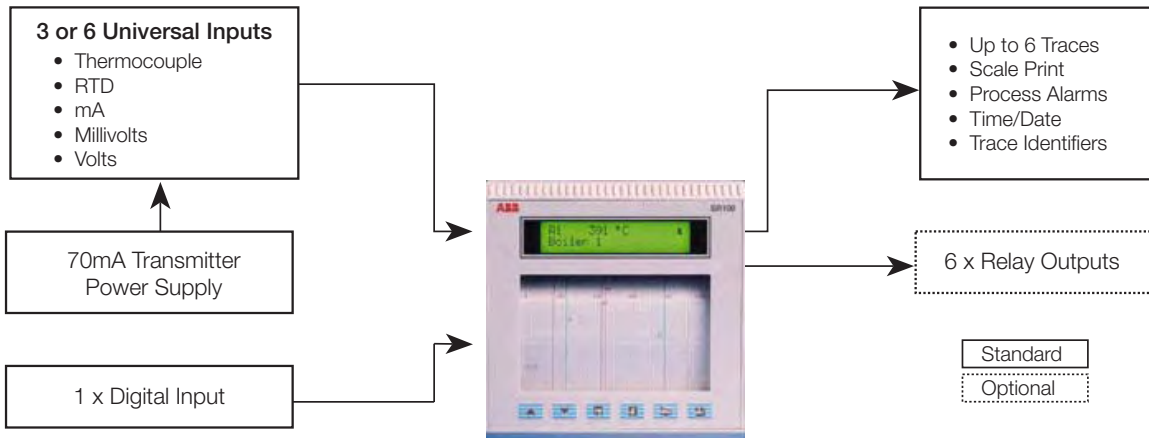

100mm Process Recorder

SR100B

SS/SR100B_5

Operation

During normal operation the display cycles through each channel in sequence showing value, units and channel tags.

Clear text prompts on the display assist the operator in accessing functions such as chart reload and alarm acknowledge. Tactile membrane keys on the front of the recorder are used to access these functions.

Password protection prevents unauthorized access to the recorder's configuration.

Quickly-fitted pen cartridges and an easily-removable chart cassette ensure simple and efficient pen and chart replacement.

Set-up

The SR100A can be easily set up to match your process in either of two ways:

Keypad – for small changes the simplest method is by means of the keypad on the front of the unit. Entry of the correct password gives access to the recorder's configuration. A simple menu structure with clear text descriptions provides an intuitive approach to the recorder set-up.

PC Configurator – the fastest way to set up SR100B recorders is by means of the PC Configurator software. This Windows™-based package provides a simple 'point-and-click' approach to generating a full recorder configuration off-line. The completed configuration can be printed out for checking or saved onto disk before being downloaded to the recorder.

An interface cable is used to provide the connection between the PC's serial port and the configuration port on the recorder.



Built-in Quality

The SR100B is designed, manufactured and tested to the highest quality standards, including ISO 9001, CSA and UL. We also have environmental accreditation to ISO 14001.

Recording

The SR100B's high-speed multi-point printing system updates all 6 traces in 800ms. This system produces continuous lines on the chart for speeds of up to 500mm/hr.

The printing sequence is intelligently managed by the recorder's control system to give priority to fast-changing signals or events, ensuring the most comprehensive process record is traced on the chart.

The SR100B supports text printing to provide annotation on the chart. In addition to the time, date, channel identity and chart speed, the recorder can print scales for each channel and alarm identification.

The 'Easy-view' facility enables the user to see the latest recordings at the push of a button.

Option Modules

All recorders are complete with 3 or 6 universal inputs for analog process signals plus a transmitter power supply for up to three 4 to 20 mA devices and a digital input.

The capabilities of your recorder can be extended further by the addition of relay option modules for 3 or 6 relays.



Innovative Design

Mechanical and electrical component count is minimized for improved performance and reliability.

An advanced analog/digital design ensures long term stability and allows range changes to be made without the need for recalibration.

Exceptional immunity to RF interference, electrical noise and line dropout (brown-out) conditions, together with the IP65 (NEMA 3) rated front face, ensure reliable operation – even in harsh industrial environments.

Long life, plug-in print cartridge with 25m roll or 12m fanfold chart, both with quick-loading cassette, and speeds from 1 to 1500mm/hr ensures minimal operating costs.

Summary Specification

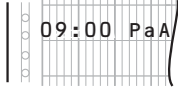

The recorder prints time, date and chart speed automatically at regular intervals. Channel scales and trace identifiers can also be printed on the chart.

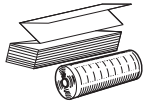

Roll or Fanfold charts with a recording width of 100mm are available with 30, 40, 50, 60, 70 and 75 divisions. Chart speed is fully adjustable between 1 and 1500mm/hour.

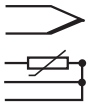

Universal process inputs support all standard types of thermocouple, RTD, 4 to 20mA signals and V, or mV, signals. 2-wire transmitter power supply is fitted as standard for up to 3 loop-powered transmitters.



Up to 12 process alarms can be set up within the recorder. Alarm status can be printed on the chart and the alarms used to operate any of the 6 relay outputs.

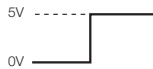

A digital input is provided as standard for remote changing of chart speed and global alarm acknowledgement.

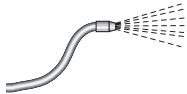

The IP65 front face and door seals protect panel-mounted recorders against water jets from most cleaning hoses and dust.

Chart Annotation

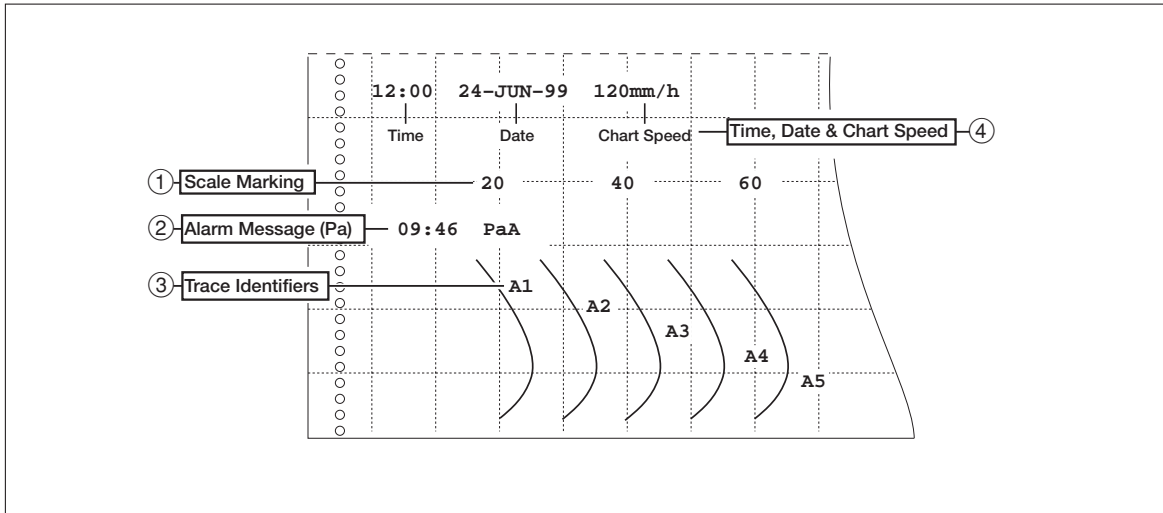

- ① **Scale Marking** – one scale per trace, printed across the width of the zone, at intervals of 20 to 240mm.
- ② **Alarm Message**
09:46 PaA
Time Assigned
Activated Channel
- ③ **Trace Identifiers** – one identifier per trace.
- ④ **Time, Date & Chart Speed** – printed on power-up and at 240mm intervals (approx.). The time is printed every 60mm (approx.).

Applications

Temperature Recording

Recording of temperature is common in a wide range of industries from Aerospace, Car Component, Food, Chemical and Kiln/Ovens using both direct-connected thermocouples and RTD or 2-wire field-mounted transmitters.

The SR100B can accept direct connection to all standard thermocouples, Pt100 and 4 to 20mA transmitters, and record on up to 6 channels.

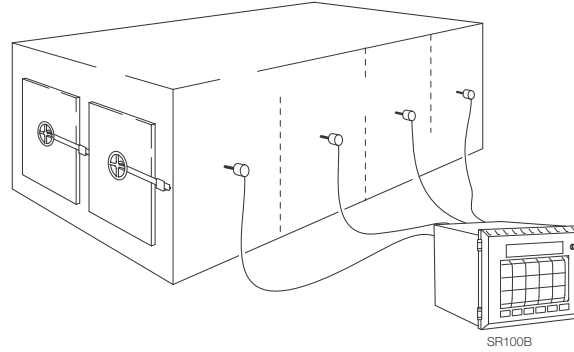

Waste Monitoring and Control

The discharge of effluent into rivers and streams is very tightly controlled and the requirement to be able to prove that the regulations have been met is extremely important.

The simplest way is to use a chart recorder connected to the pH transmitter in the discharge line, giving the added advantage of monitoring flow rates for records of discharges.

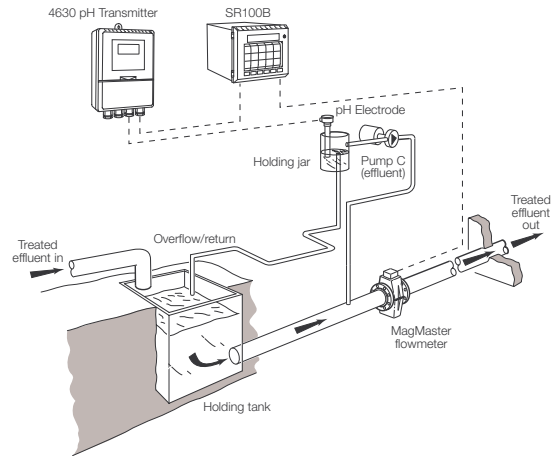

Temperature Monitoring and Alarms

The simplest and easiest way to do this is with the SR100B strip chart recorder, which can take up to 6 inputs from RTDs spread across a cold store or a number of food preparation areas.

At a chart speed of 20mm/hour the unit provides recording for one month, as well as alarm functions, when fitted with relay output modules.

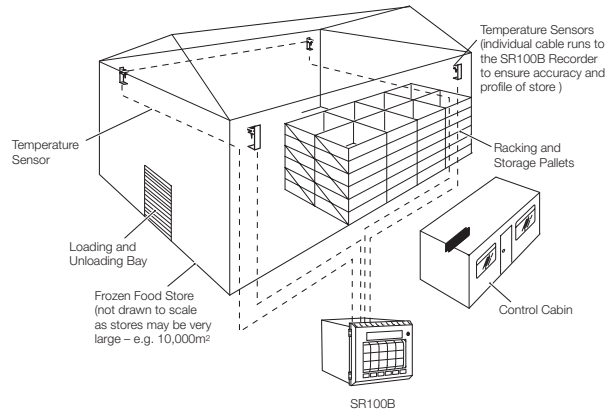

100mm Process Recorder

SR100B

SS/SR100B_5

Specification

Summary

3 or 6 traces
100mm wide roll or fanfold chart
Fully user-programmable
IP65 (NEMA 3) protection
PC configuration

Operation

Display

Alphanumeric and bargraph,
2 x 20-character long-life back-lit LED
100 segment bargraph

Languages

English, French, German – user selectable

Configuration

User-defined via front panel or PC Configurator

Chart

Traces

3 or 6 multicolor or digital data recording

Colors

Three traces Pen 1 = Red, Pen 2 = Green, Pen 3 = Blue
Six traces per DIN standard

Pen Life

4 months (typical)

Chart

12m Fanfold or 25m Roll
Quick-load cassette
Standard chart graduation: 50 divisions
30, 40, 60, 70, 75 divisions also available

Chart Speed

Configurable in 1mm steps between 1 and 1500mm/hr
Remote chart ON/OFF

Trace Response

800ms for update of six traces

...Specification

Analog Inputs

Number

3 or 6 Standard Analog Inputs

Input sampling rate

180ms per channel

Type

Universally Configurable to provide:

- Thermocouple (THC)
- Resistance thermometer (RTD)
- Millivolt
- Current
- DC voltage
- Resistance

Linearizer functions

Programmable for all inputs including: $\sqrt{\quad}$, $x^{3/2}$, $x^{5/2}$

THC types B, E, J, K, R, S, T, L, N or Pt100

Broken sensor detection

Programmable UP/DOWN scale or NONE

RTD short/open circuit detection

Cold junction compensation

Automatic CJC incorporated as standard

Input impedance

- Current 10 Ω
- DC voltage 500k Ω
- mV & THC >10M Ω

Transmitter power supply

70mA max. powers three loops, fitted as standard

Input Isolation

Standard input module

- Analog channel-to-channel 12V (0V with RTDs)
- Input to ground 500V DC dielectric strength
- Common mode >140dB at 50/60Hz with 500 Ω imbalance resistance
- Series mode >60dB at 50/60Hz
- Filtering 0 to 60s 'Smart' digital filter

Input Temperature Limits

THC /RTD Type	°C			°F		
	Min.	Max.	Min. Span	Min.	Max.	Min. Span
Type B	-18	1800	710	0	3272	1278
Type E	-100	900	45	-148	1652	81
Type J	-100	900	50	-148	1652	90
Type K	-100	1300	65	-148	2372	117
Type L	-100	900	50	-148	1652	90
Type N	-200	1300	90	-328	2372	162
Type R & S	-18	1700	320	0	3092	576
Type T	-250	300	60	-418	572	108

Performance accuracy is not guaranteed below 400°C (752°F) for types B, R and S thermocouples.

Min. span below zero: Type T 70°C/126°F
Type N 105°C/189°F

THC standards DIN 43710 (IEC 584)

RTD	Min.	Max.	Min. Span	Min.	Max.	Min. Span
	-200	600	25	-328	1112	45

3-wire platinum, 100 Ω per DIN 43760 standard (IEC751), with range of 0 to 400 Ω .

RTD standards DIN 43760 (IEC 751)

Electrical Limits

Input Type	Min. Value	Max. Value	Min. Span
Millivolts	-2000	2000	2.5
Volts	-20	20	0.25
Milliamps	-100	100	0.25
Resistance	0	8000	10

100mm Process Recorder

SR100B

SS/SR100B_5

Accuracy

Pen

Resolution 0.2% of span

Display

Intrinsic error for reference conditions, 20°C.

mV inputs 0.1% of reading $\pm 10\mu\text{V}$

THC inputs as mV equivalent plus linearizer error

CJC $<0.05^\circ\text{C}/^\circ\text{C}$ change in ambient

mA, V inputs 0.2% of reading or $\pm 2\mu\text{A}$

RTD inputs $<\pm 0.2\%$ of reading or $\pm 0.5^\circ\text{C}$

Channel-to-channel offset $<20\mu\text{V}$ or $<0.025\Omega$ without using individual channel offset correction

Engineering range -999 to +9999

Display resolution for spans $>4000 - \pm 2$ digits
for spans $<4000 - \pm 1$ digit

Long term drift $<0.01\%$ reading, or $<\pm 5\mu\text{V}$ annually

Physical

Size

144mm (5.67 in.) x 144mm (5.67 in.)
x 230mm (9.05 in.) (depth behind panel)

Weight

3.3kg (7¹/₄ lbs.) approx.

Panel cut-out

138mm (5.43 in.) x 138mm (5.43 in.)

Case material

Stainless steel

Door material

Glass-filled polycarbonate

Window material

Polycarbonate

Electrical

Power supply

85 to 265V 50/60Hz

or 10V to 30V DC

or 24V AC

Power consumption

25VA max.

20W DC (typical)

Electrical safety

EN61010-1

CE Marked instruments meet EU regulations

Electrical connections

Screw terminals

Environmental

Operating limits

5 to 50°C (41 to 122°F), 95%RH non-condensing

80%RH for chart

Temperature stability

0.02% of reading/ $^\circ\text{C}$, or $2\mu\text{V}/^\circ\text{C}$ whichever is greater

Protection

Front face IP65/NEMA 3

Rear of instrument IP20

Line interruption

$<80\text{ms}$ loss, no effect

$>80\text{ms}$ loss, auto-reset and restart

IEC Part IV level 3

Electromagnetic capability

EN 50081-2

EN 50082-2

CE Marked

EMC

Design & manufacturing standards

CSA General Safety Approved

UL General Safety Approved

Emissions and Immunity

Meets requirements of IEC 61326 for an Industrial Environment

Option Modules

Up to two modules can be fitted

Relay output module

Three relays per module

Type single pole changeover

Rating 250V AC 5A (non-inductive load)

250V DC 25W maximum

100mm Process Recorder
SR100B

SS/SR100B_5

Ordering Information

SR100B 100mm Process Recorder	SR10	X	B/	X	0/	X	X	0	0	0	0/	X	X	X	XXXX	
Number of Traces, Input Channels and Dielectric Strengths																
3 traces (12V channel-to-channel)																
6 traces (12V channel-to-channel)																
Build																
ABB Standard																
Option Module B																
No additional outputs																
3 relay outputs																
Option Module C																
No additional outputs																
3 relay outputs																
Case & Door Type																
Standard case																1
Standard case + terminal cover																2
Chart Drive																
Roll chart																1
Fanfold chart*																2
Power Supply																
85 to 265V AC																1
10 to 30V DC																3
24V AC																4
Programming/Special Features																
Configured to factory standard																ST
Configured to customer requirements																CM
Special features																SPXX

* Easy View feature available only with Roll Chart option.

Accessories

PC Configuration kit (part no. C100/0700)